

► SUMIDERO PISCINA HORMIGÓN Ø180 / MAIN DRAIN
CONCRETE POOL Ø180

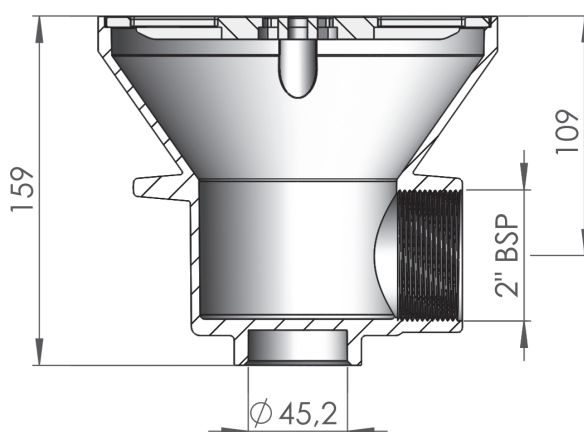

Complies with Standards
EN 16582-1



DESCRIPCIÓN DEL PRODUCTO / PRODUCT DESCRIPTION

Sumidero circular con salida lateral. La rejilla del sumidero se suministran con tratamiento UV. Cuerpo y rejilla en ABS color blanco. Fijación rejilla mediante tornillos.

Recomendaciones:





- Velocidad de paso de 0,5 m/seg.
- Velocidad máx de aspiración en tubería de 1,5 m/seg.
- Colocar mínimo 2 sumideros por piscina.
- Distancia mínima entre sumideros: >2 m.

Circular main drain with side outlet. The grille of the main drain is provided with UV protected. Body and grille in white ABS. Fixed grille with screws.

Recommendations:

- *Water passing speed 0.5 m/seg.*
- *Maximum suction velocity 1.5 m/seg.*
- *Place minimum 2 main drains for pool.*
- *Minimum distance between drains: >2 m.*

► CARACTERÍSTICAS TÉCNICAS / TECHNICAL CHARACTERISTICS

CARACTERÍSTICAS / CHARACTERISTICS	01467	06583
Tipo de rosca <i>Thread type</i>	EU	NTP
Conexión lateral <i>Side connection</i>	2"	2"
Caudal máximo <i>Maximum flow rate</i>	13 m ³ /h	13 m ³ /h
Piscina <i>Swimming pool</i>	Hormigón <i>Concrete</i>	Hormigón <i>Concrete</i>
Colores <i>Colours</i>	  CL090  CL129  CL144	

► LOGÍSTICA / LOGISTICS

EMBALAJE Y PALETIZADO / PALLETIZED AND PACKAGING

Medidas caja standard (mm) - Standard box sizes (mm)	396 x 396 x 213
Unidades / Caja standard - Units / Standard box	4
Volumen / Caja standard (m³) - Volume / Standard box (m³)	0,035
Peso / Caja standard (Kg) - Weight / Standard box (Kg)	2,82
Medidas palet (mm) - Pallet sizes (mm)	1000 x 1200 x 2400
Unidades / Palet - Units / Pallet	216
Volumen / Palet (m³) - Volume / Pallet (m³)	2,227
Peso / Palet (Kg) - Weight / Pallet (Kg)	160,84

► CAJA STANDARD / STANDARD BOX

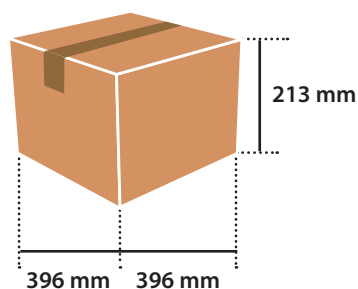

► PALET / PALLET

