

COLLEZIONE 2025  
COLLECTION

*Dolce Vita*



il tuo specchio d'acqua / your own pool

50°

1974  
2024

2025

PISCINE  
**LAGHETTO®**

# COLLEZIONE 2025 COLLECTION

*Dolce Vita*



**ATTENZIONE**



## **GARANZIA ESTESA** / Extended warranty

**Per ottenere l'estensione di garanzia pubblicizzata su questo catalogo il prodotto deve essere registrato dal cliente finale sul sito [www.piscinelaghetto.com](http://www.piscinelaghetto.com) entro 30 giorni dalla data di consegna della piscina, comprovata da regolare ricevuta fiscale/fattura.**

In order to obtain the extended warranty advertised in this catalogue, the product must be registered by the end customer on [www.piscinelaghetto.com](http://www.piscinelaghetto.com) within 30 days from the date of sale/delivery of the pool, proven by regular fiscal receipt/invoice.

PISCINE  
**LAGHETTO®**

Fluidra Commerciale Italia SpA si riserva il diritto di apportare modifiche senza obbligo di preavviso. I prodotti illustrati in questo listino sono solo per uso privato.

Qualsiasi utilizzo pubblico o commerciale deve essere autorizzato da Fluidra Commerciale Italia SpA che non si assume la responsabilità per la sicurezza, per la filtrazione o la purezza dell'acqua. L'acquirente è tenuto ad osservare la normativa del Paese in cui la piscina è installata.

Immagini non contrattuali a scopo puramente illustrativo.

Attenzione: I colori indicati in questo listino hanno la sola finalità di illustrare il prodotto. Non si riferiscono ad un colore specifico, pertanto si consiglia di visionare e far visionare direttamente i prodotti e/o i campioni di materiale e tessuto originali Piscine Laghetto.

VIETATA LA RIPRODUZIONE ANCHE PARZIALE DEL PRESENTE CATALOGO / LISTINO

Fluidra Commerciale Italia SpA reserves the right to make changes without prior notice. The products illustrated in this price list are for private use only.

Any public or commercial use has to be authorized by Fluidra Commerciale Italia SpA, which does not take responsibility for safety, filtration or purity of water. The purchaser is obliged to observe the regulations of the country in which the pool is installed.

Non-contractual images for illustrative purposes only.

Please note: The colours shown in this price list are for the sole purpose of illustrating the product. They do not refer to a specific colour. We therefore recommend that you view the products and/or the original Piscine Laghetto material and fabric samples directly.

REPRODUCTION, EVEN PARTIAL, OF THIS CATALOGUE / PRICE LIST IS FORBIDDEN

	PAGINA
<b>UNA STORIA DI FAMIGLIA</b> A family history	4
<b>PRESENTAZIONE DOLCEVITA FUORITERRA</b> Introduction of above ground DolceVita	10
<b>DOLCEVITA FINITURA RATTAN</b> DolceVita Rattan finish	24
<b>DOLCEVITA FINITURA DIVA</b> DolceVita Diva finish	28
<b>DOLCEVITA FINITURA DIVA CON LOCALE TECNICO INTEGRATO (LTI)</b> DolceVita Diva LTI finish	32
<b>DOLCEVITA VERSIONE NAKED</b> DolceVita Naked version	36
<b>ACCESSORI</b> Accessories	39
<b>PESI E MISURE</b> Weights and sizes	50
<b>ALLEGATI TECNICI</b> Technical drawings	54
<b>GARANZIA</b> Warranty	60

Tutti i contenuti di questa comunicazione, ivi compresi i testi, la grafica, il layout, le fotografie, appartengono, ove non diversamente specificato, a Fluidra Commerciale Italia SpA e non potranno essere in alcun modo essere riprodotti, pubblicati, commercializzati, distribuiti, trasmessi e comunque utilizzati da terzi senza preventiva autorizzazione scritta da parte di Fluidra Commerciale Italia SpA. I marchi, i loghi e le denominazioni di Fluidra Commerciale Italia SpA, dei suoi Partner e/o di terzi appartengono ai rispettivi proprietari e sono protetti dalle normative vigenti in materia di diritto d'autore, brevetti e proprietà intellettuale. Ogni violazione sarà perseguita ai sensi di legge.

All the contents of this communication, including text, graphics, layout, photographs, belong, unless otherwise specified, to Fluidra Commerciale Italia SpA and may not in any way be reproduced, published, marketed, distributed, transmitted or in any way used by third parties without prior written authorisation from Fluidra Commerciale Italia SpA. The trademarks, logos and names of Fluidra Commerciale Italia SpA, its partners and/or third parties belong to their respective owners and are protected by current copyright, patent and intellectual property laws. Any violation will be prosecuted according to the law.

# UNA STORIA DI FAMIGLIA

## A FAMILY HISTORY

50  
1974  
2024

Laghetto  
PISCINE

La storia di Piscine Laghetto inizia in un'afosa estate cremonese: era il 1974 e nel cortile di Agrisilos, azienda produttrice di teli per l'agricoltura, compariva una piscina tonda in telo gommato con anello gonfiabile per i bambini dei titolari, che potevano giocare e rinfrescarsi nella calda estate padana.

### “LE GRANDI IDEE SPESSO NASCONO DAL CASO”

#### **Era appena stata creata la prima Laghetto.**

Un'idea semplice che si rivelò fin dall'inizio vincente, attirando immediatamente l'attenzione di tutti, tanto che venne subito depositato il brevetto n° 168558.

Erano anni di benessere e crescita economica e l'idea di una piscina da giardino facile da realizzare, bella e durevole conquistò il pubblico a tal punto che in poco tempo Piscine Laghetto diventò il brand di riferimento per le piscine residenziali fuori terra.

**Quella di Piscine Laghetto è una storia di successo, di grandi intuizioni, progetti sempre nuovi ed all'avanguardia, caratterizzati dall'attenzione alla qualità ed all'assistenza, senza mai perdere di vista lo stile ed il design italiani.**

Con la sua vasta gamma di prodotti caratterizzati da un design unico e inconfondibile e in 50 anni di storia Piscine Laghetto è entrata nelle case e nei giardini di 250.000 famiglie in tutto il mondo.



1974

## “GREAT IDEAS OFTEN ARISE BY CHANCE”

The story of Piscine Laghetto began in a muggy Cremona summer: it was 1974 and in the courtyard of Agrisilos, a company producing tarpaulins for agriculture, a round rubberised sheet swimming pool with an inflatable ring appeared for fun to let the owners' children play and cool off in the heat of the Po Valley summer.

### **The first Laghetto had just been created.**

A simple but winning idea has drawn everyone's attention, to such an extent that patent No. 168558 was immediately filed.

Those were years of prosperity and economic growth and the idea of a garden swimming pool that was easy to build, beautiful and durable won over the public: in a short time Piscine Laghetto became the reference brand for above ground residential swimming pools.

**The Piscine Laghetto story is a story of success, of great intuition, always new and avant-garde projects, characterised by attention to quality and service, without ever losing sight of Italian style and design.**

During the last 50 years Piscine Laghetto has entered the homes and gardens of 250,000 families all over the world with its vast range of products characterised by a unique and unmistakable design.



CLASSIC

BLUESPRING

*Dolce Vita*

POP!

PLAYA

ANNI 80'

ANNI 90'

2007

2014

2014

# L'AZIENDA > THE COMPANY

**PISCINE LAGHETTO®** da sempre si distingue per la capacità di cogliere ed anticipare le tendenze e le aspettative dei suoi clienti, cercando di proporre prodotti tecnicamente eccellenti ed allo stesso tempo iconici e di design.

Il servizio di assistenza dopo la vendita è un'altra delle priorità dell'azienda, perché chi sceglie un prodotto Laghetto possa godersi la propria piscina in modo semplice, sicuro, senza pensieri fin dal primo giorno.

Dal 2017 Agrisilos – Piscine Laghetto è entrata a far parte del **GRUPPO FLUIDRA**, gruppo multinazionale spagnolo quotato in Borsa, leader su scala mondiale nel settore della piscina e del benessere, che nel 2019 è entrato in IBEX 35, la lista delle 35 aziende più capitalizzate di Spagna.



**Piscine Laghetto®** has always stood out for its ability to understand and anticipate the trends and expectations of its customers, striving to offer products that are technically excellent and at the same time iconic and design-oriented.

The after-sales service is another of the company's priorities, so that those who choose a Laghetto product can enjoy their pool easily, safely and without worries from day one.

Since 2017, Agrisilos - Piscine Laghetto has become part of the Fluidra Group, a listed Spanish multinational group, world leader in the pool and wellness sector, which in 2019 entered IBEX 35, the list of the 35 most capitalised companies in Spain.

## FLUIDRA

PISCINE  
LAGHETTO®

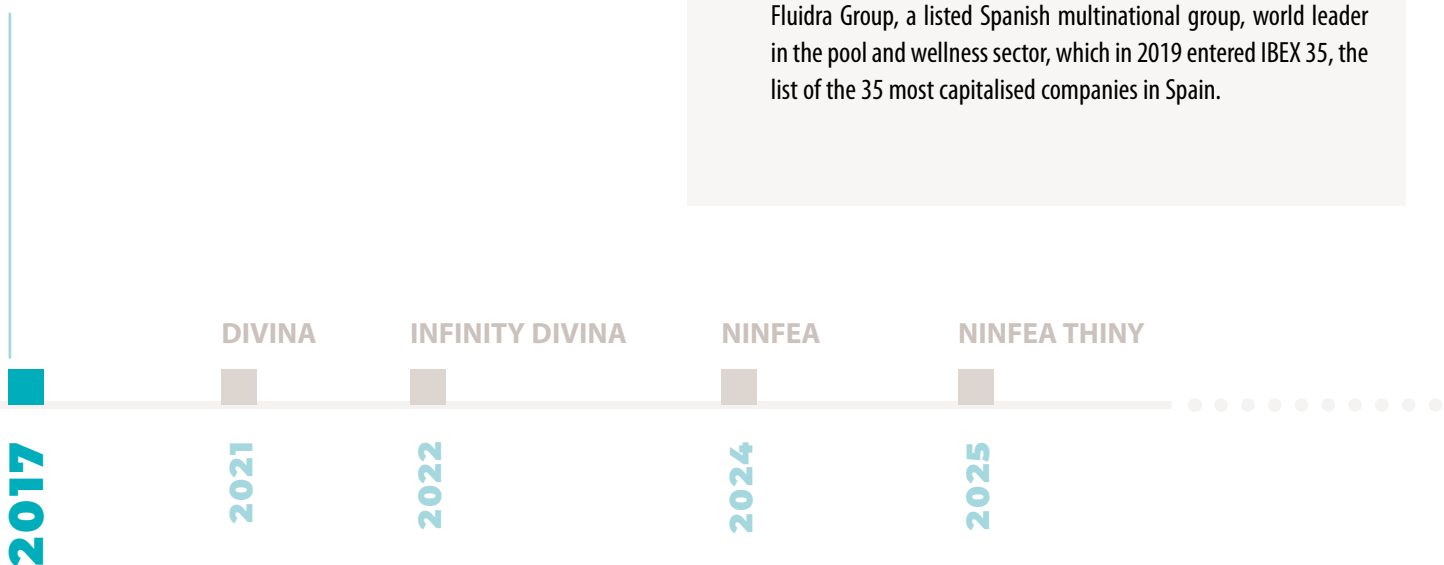



**Il reparto produttivo di Piscine Laghetto** si trova da sempre nello stabilimento di Vescovato (CR).

Qui l'azienda si estende su un'area totale di circa 10.000 mq, che comprendono l'area produttiva, parte del magazzino e gli uffici.

Per offrire ai propri clienti il migliore servizio possibile, negli ultimi anni l'azienda ha investito nell'ampliamento dell'area di stoccaggio e di spedizione, garantendo così una maggiore affidabilità e puntualità anche in piena stagione.

## IL NOSTRO FOCUS È LA QUALITÀ !

QUALITY IS OUR FOCUS !

**The production department of Piscine Laghetto** has always been located in the plant of Vescovato (CR). Here the company covers a total area of around 10,000 square metres, in which the production area, part of the warehouse and the offices are located.

In order to offer the best service to its customers, the company has recently invested in the expansion of the storage and shipping area, which will allow us to be more reliable and punctual during high season.

PISCINE  
**LAGHETTO**<sup>®</sup>

L'AZIENDA > THE COMPANY

# ITALIA E DESIGN > ITALY AND DESIGN

## "Siamo consapevoli di creare nuovi mondi e nuovi concetti di stile".

Fin dalla nascita del marchio, Piscine Laghetto è stata dirompente nel mondo della piscina e non solo.

**Il forte DNA italiano fatto di arte, cultura, design e genialità si ritrova nella progettazione di tutti i prodotti.**

La creatività dell'azienda ha portato negli anni ad un "upgrade" del prodotto stesso, riqualificandolo e rinnovandolo in termini di design, immagine e mercato di riferimento.

Per Piscine Laghetto la piscina diventa così un oggetto di arredo che si inserisce piacevolmente nel giardino, sotto un portico, in una terrazza o anche all'interno della casa.

Un nuovo concetto di "arredare con l'acqua" si impone con la sua originalità, eleganza ed unicità e proietta l'essenza del prodotto al di fuori del mondo piscina.

Non solo un oggetto estivo da presentare per completare un ambiente outdoor, ma il cuore di un progetto innovativo di design e di arredo che diventa trasversale a tutte le stagioni e a tutti gli ambienti.



## "We are conscious of creating new worlds and new styles".

Since the birth of the brand, Piscine Laghetto has been disruptive in the swimming pool world and beyond.

**The strong Italian DNA of art, culture, design and geniality can be found in the design of all products.**

Over the years, the company's creativity has led to an upgrade and renewal of the product itself, in terms of design, image and target market.



The swimming pool becomes a piece of furniture that fits pleasantly into the garden, a porch, a terrace or even inside the home.

A new concept of "furnishing with water" imposes itself with its originality, elegance and uniqueness, projecting the essence of the product outside the pool world.

The pool becomes not just a summer object that completes an outdoor environment, but the heart of an innovative design and furnishing project.

This way it becomes transversal to all seasons and environments.





Questo nuovo modo di concepire il prodotto è frutto di anni di attiva presenza alle principali fiere del settore arredamento, eventi Fuorisalone del Mobile con importanti installazioni avveniristiche e cooperazioni prestigiose, fino alla significativa esperienza dal 2022 al 2023 di uno Showroom a Milano Brera, punto di riferimento e cuore del Design internazionale. Nell'autunno 2023 l'azienda ha deciso di dotare la propria sede di Vescovato di un ampio showroom aperto ai propri rivenditori e concepito come spazio ispirazionale per la diffusione del design Piscine Laghetto.

L'ingresso dell'azienda nel gruppo multinazionale spagnolo Fluidra ha permesso di ampliare i suoi mercati di riferimento su scala mondiale, senza mai perdere la propria **italianità, da sempre l'essenza di Piscine Laghetto.**

## LA NOSTRA ANIMA È TUTTA ITALIANA ! OUR SOUL IS ALL ITALIAN !

This new way of conceiving the product is the result after years of active presence at the main furnishing sector fairs, Fuorisalone del Mobile events with important futuristic installations and prestigious co-operations, up to the significant experience from 2022 to 2023 of a Showroom in Milano Brera, a reference point and heart of the international Design. In autumn 2023 the company decided to equip its Vescovato headquarters with a large showroom open to its dealers and conceived as an inspirational space for the diffusion of Piscine Laghetto design.

The company's entry into the Spanish multinational group Fluidra has allowed it to expand its reference markets on a global scale, without ever losing **the distinctive Italian character that is the essence of Piscine Laghetto.**



PISCINE  
**LAGHETTO**<sup>®</sup>

ITALIA E DESIGN > ITALY AND DESIGN

# Dolce Vita



## ELEGANZA E TECNOLOGIA

**DOLCEVITA** è, nel mercato della piscina fuori terra, il prodotto che negli ultimi anni ha maggiormente incontrato gusti e aspettative dei clienti più esigenti. Grazie al suo design elegante e innovativo - e alla solida tecnologia Laghetto presente sul mercato da quasi 50 anni - ha rinnovato il mondo delle piscine fuoriterra.

Si tratta di un prodotto al tempo stesso facile da montare e funzionale, dall'indubbio impatto estetico, che può essere inserito in qualsiasi tipo di contesto, anche laddove non sia possibile realizzare la classica piscina interrata. La sua versatilità permette un montaggio facile e veloce anche in zone con permessi di utilizzo solo stagionale.

Dolcevita fornisce un sistema di ricircolo e filtrazione che consente la massima igiene e la massima purezza dell'acqua.



## ELEGANCE & TECHNOLOGY

**Dolcevita** is, in the above-ground pool market, the product that in recent years has best met the tastes and expectations of the most demanding customers, renewing the world of above-ground pools. This has been possible thanks to the solid Laghetto technology - on the market for almost 50 years - and its elegant and innovative design.

A product that is at the same time easy to assemble, functional, and of undoubted aesthetic impact. It can be placed in any type of context, even where the classic inground pool can't be installed.

Its versatility allows a quick and easy installation even in areas with only seasonal use permits.

Dolcevita provides a recirculation and filtration system that allows the highest hygiene and purity of water.



## COS'È DOLCEVITA? > WHAT IS DOLCEVITA?

**DOLCEVITA®** è una piscina a struttura modulare realizzata con elementi prefabbricati ed opportunamente assemblati in opera che sorreggono il telo vasca: una membrana tensostrutturale impermeabile che viene fornita già saldata e forata per accogliere gli accessori interni della piscina.

**DOLCEVITA®**, indipendentemente dalla versione, deve essere posizionata sopra ad un piano di supporto idoneo a sostenere il peso dell'acqua e della struttura stessa della piscina:

- In presenza di un basamento in conglomerato cementizio (esistente o di nuova realizzazione), i moduli principali potranno essere fissati utilizzando idonei tasselli meccanici o fissaggi chimici, a seconda delle caratteristiche del supporto medesimo.
- In assenza di un basamento in c.a. è necessario installare lo specifico Basamento per montaggio su terra tra il fondo della piscina ed il terreno.

**DOLCEVITA®** is a swimming pool with a modular structure made of prefabricated and suitably assembled elements that support the pool cover: a waterproof tensile-structural membrane that is supplied already welded and perforated to accommodate the pool's internal accessories.

**DOLCEVITA®**, regardless of the version, must be placed on a support surface suitable for sustaining the weight of the water and the pool structure itself:

- In the presence of a concrete base (existing or new), the main modules can be fixed using suitable mechanical anchors or chemical fixings, depending on the characteristics of the base.
- In the absence of a reinforced concrete base, it is necessary to install the specific Basement for ground installing between the bottom of the pool and the ground.

## UNA STRUTTURA, QUATTRO STILI > ONE STRUCTURE, FOUR STYLES

**Dolcevita è disponibile in quattro modelli, ciascuno con materiali di altissima qualità che ne garantiscono la durata nel tempo. DolceVita® is available in four models, each with top-quality materials that guarantee long-lasting use.**

### DIVA

Di nome e di fatto: dal design lineare e moderno, la soluzione con pannellatura e bordo integrato;

Diva in name and in fact: with its linear and modern design, the solution with panelling and integrated edge;



### DIVA LTI

Sempre Diva, ma ancor più funzionale grazie alla presenza di un locale tecnico integrato;

Diva LTI still Diva, but even more functional thanks to an integrated technical room;



# STILE DOLCEVITA IN TANTE DIMENSIONI

## DOLCEVITA STYLE IN MANY SIZES

DIVA   RATTAN   NAKED					
MOD.	SPECCHIO D'ACQUA water size (m)	INGOMBRO TOTALE overall sizes (m)	ALTEZZA ACQUA water height (m)	ALTEZZA TOTALE total height (m)	VOLUME (mc)
24	2 x 4	2,4 x 4,4	1,2	1,3	9,6
25	2 x 5	2,4 x 5,4	1,2	1,3	12
35	3 x 5	3,4 x 5,4	1,2	1,3	18
36	3 x 6	3,4 x 6,4	1,2	1,3	21,6
37	3 x 7	3,4 x 7,4	1,2	1,3	25,2
48	4 x 8	4,4 x 8,4	1,2	1,3	38,4
49	4 x 9	4,4 x 9,4	1,2	1,3	43,2
510	5 x 10	5,4 x 10,4	1,2	1,3	60

DIVA LTI					
MOD.	SPECCHIO D'ACQUA water size (m)	INGOMBRO TOTALE overall sizes (m)	ALTEZZA ACQUA water height (m)	ALTEZZA TOTALE total height (m)	VOLUME (mc)
35	3 x 5	3,4 x 6,1	1,2	1,3	18
36	3 x 6	3,4 x 7,1	1,2	1,3	21,6
37	3 x 7	3,4 x 8,1	1,2	1,3	25,2
48	4 x 8	4,4 x 9,1	1,2	1,3	38,4
49	4 x 9	4,4 x 10,10	1,2	1,3	43,2

measure indicative (non vincolanti) the measures are indicatives

## RATTAN

Dal design provocatoriamente Country è il perfetto connubio tra design e tecnologia;

With its provocative country design, it is the perfect combination of design and technology;



## NAKED

La più versatile tra le Dolcevita, altamente personalizzabile secondo i gusti del cliente.

Unico limite: la fantasia!

The most versatile Dolcevita, highly customisable according to your taste. Imagination will be its only limit.



# I PARTICOLARI DEL KIT PISCINA

## POOL KIT DETAILS

### STRUTTURA > STRUCTURE

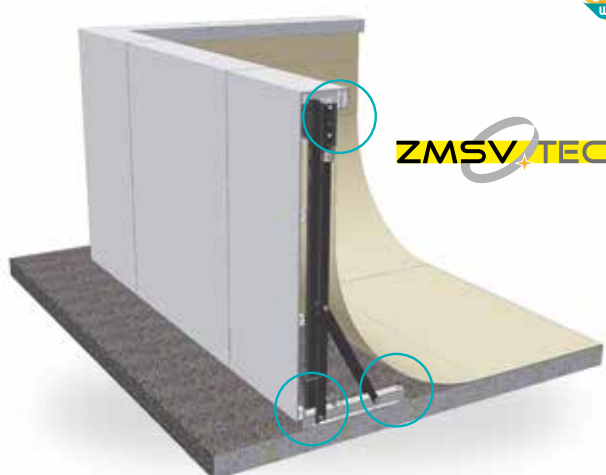

### STRUTTURA

La struttura di DolceVita è stata specificatamente studiata e progettata dagli uffici tecnici Laghetto utilizzando acciaio Magnelis® con verniciatura a polvere (tecnologia ZMSV-TEC).

Questo speciale trattamento consente una maggiore resistenza ai fenomeni di corrosione.

In generale, la qualità dei materiali impiegati garantisce affidabilità costruttiva e maggiore durata nel tempo.

Il piede del traliccio, come anche la bulloneria, sono in acciaio inox.

Nel dettaglio:

#### MONTANTI TRALICCIO

Acciaio zinco magnesio verniciato a polvere.

Piedistallo in acciaio inossidabile AISI304.

#### LONGHERONI TRALICCIO

Acciaio zinco magnesio verniciato a polvere.

#### BULLONERIA

Acciaio inossidabile A2.



### STRUCTURE

The structure of DolceVita, specifically studied and designed by Laghetto's technical offices, is made of Magnelis steel with a powder coating (ZMSV-TEC technology).

This special treatment allows greater resistance against corrosion.

In general, the quality of the materials used guarantees constructive and operational reliability over time.

The trellis foot and all hardware are made of stainless steel.

In detail:

#### TRELLIS PILLARS

Zinc magnesium steel powder coated structure with stainless steel AISI304 piece of support.

#### METAL STRUT

Zinc magnesium steel powder coated.

#### NUTS AND BOLTS

A2 stainless steel.

## TESSUTO > LINER



### TESSUTO

**I teli vasca DolceVita vengono realizzati in tessuto Trevira spalmato da 1000 g/mq, prodotto esclusivo Piscine Laghetto.**

Il telo, membrana tensostrutturale altamente resistente alla trazione, viene successivamente trattato anti-UV grazie all'utilizzo di additivi speciali che limitano esponenzialmente il deterioramento del materiale stesso.

**Il telo DolceVita viene testato per resistere alle più estreme prove di trazione (430 kg ogni 5 cm).**

La grande esperienza di Piscine Laghetto nella produzione e nella lavorazione di teli per piscine è sinonimo di assoluta qualità e affidabilità.

I 50 anni circa di ricerca e sviluppo, unitamente ad una stretta collaborazione con aziende fornitrici di tessuti, hanno portato alla formulazione di teli strutturalmente e chimicamente specifici per il settore piscina.

Le macchine saldatrici, cuore pulsante del reparto produttivo, sono state appositamente studiate e realizzate per rispondere alle esigenze tecnologiche e produttive aziendali.

Ogni telo è quindi specificatamente saldato per avere la massima resistenza alle varie sollecitazioni. Grazie a questo i Prodotti Laghetto sono unici e si distinguono dal resto del mercato.



### DOLCEVITA



### LINER

DolceVita pool liners are made from 1000 g/sqm coated Trevira fabric, an exclusive Piscine Laghetto product.

The liner, a highly tensile-resistant membrane, is subsequently treated anti-UV thanks to the use of special additives that exponentially limit the ageing of the material. The DolceVita liner is tested to withstand the most extreme tensile tests (430 kg every 5 cm).

Piscine Laghetto's vast experience in the production and processing of pool liners it's a synonym of absolute quality and reliability.

Almost 50 years of research, development and close collaboration with carefully selected fabric suppliers have led to the formulation of sheets that are structurally and chemically specific for the swimming pool sector. The welding machines, the most important part of the production department, are specifically designed and manufactured to meet the company's technological production requirements.

Each liner is therefore specifically welded to get the maximum resistance to various stresses, giving Laghetto products the quality and efficiency that distinguish and differentiate them from the rest of the market.

# I PARTICOLARI DEL KIT PISCINA

## POOL KIT DETAILS

### PANNELLATURE > PANELS

#### PANNELLATURA DOLCEVITA

**Tratto distintivo di DolceVita sono i pannelli che la rendono un prodotto dal design unico.**

La pannellatura è composta da una struttura in alluminio verniciato su cui viene intrecciata a mano una fibra sintetica di polipropilene ottenuta mediante estrusione.

**L'artigianalità della lavorazione dona un aspetto unico a ciascuna piscina, differenziandola sul mercato.**

Questo materiale di lunga durata è particolarmente resistente ai vari agenti atmosferici e ne è stata testata la resistenza ai raggi UV per una esposizione di oltre 3000 ore.

Ottima anche la resistenza ai grandi sbalzi di temperatura. Facile è la manutenzione oltre che la pulizia, che avviene tramite detergenti neutri non aggressivi.

Le finiture DolceVita adottano due differenti tipologie di pannellature:

**RATTAN**, con bordo in ecolegno composito, e **DIVA (anche nella variante Diva LTI)** con l'esclusiva finitura che integra pannello e bordo in un unico pezzo per un design pulito e moderno.

#### PANELS

A distinctive feature of DolceVita, the panels make it a uniquely designed product.

The panelling consists of a painted aluminium structure onto which a synthetic polypropylene fibre obtained by extrusion is woven by hand.

The craftsmanship gives each pool a unique appearance, differentiating it on the market.

This durable material is particularly resistant to various atmospheric agents and has been tested for UV resistance for an exposure of over 3000 hours.

Resistance to wide temperature variations is also excellent. Maintenance is easy as well as cleaning, to be done with neutral non-aggressive detergents.

The DolceVita finishing adopts two different types of panels:

Rattan, with a composite eco-wood edge, and Diva (also in Diva LTI version) with finishing that integrates panels and edge in a single piece with a linear and modern looking.



#### RATTAN

coffee

grey

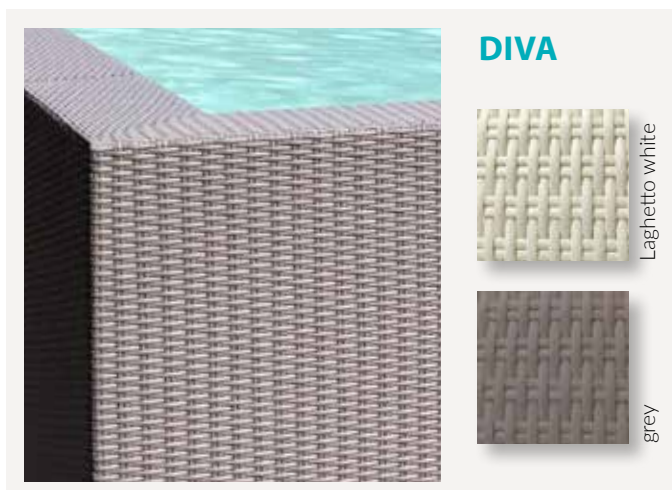

#### DIVA

Laghetto white

grey



## BORDI ECOLEGNO > ECO WOOD EDGES

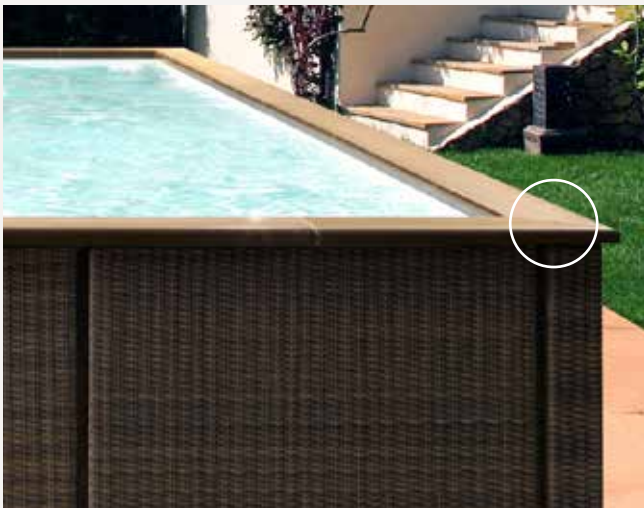

### BORDO ECOLEGNO

**Nelle finiture RATTAN e NAKED, la piscina DolceVita è contornata dal bordo in legno composito.**

È disponibile in due colorazioni: Ardesia e Tabacco.

L'ecolegno, autentico ed elegante, è una scelta estetica, tecnologica e orientata alla sostenibilità.

Un legno performante che dura nel tempo, rispettando la natura.

### ECO WOOD EDGE

In Rattan and Naked versions, the DolceVita pool is surrounded by a composite wood edge.

It is available in two colours: Ardesia and Tabacco.

An authentic and elegant product, chosen as aesthetic and technological sustainable solution.

A high-performance composite long lasting wood, respecting the nature.



Tabacco

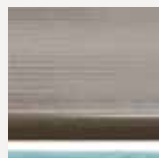

Ardesia

## FARI A LED > LED SPOTS

### FARI A LED BIANCHI

**Ogni piscina DolceVita prevede la fornitura di serie di uno o due faretto a Led bianchi (a seconda della misura scelta) della linea Laghetto** posizionati sul telo vasca che donano giochi di luce d'effetto, sia di giorno che di notte.

Questi fari uniscono un rendimento luminoso altamente performante, con consumi elettrici ridotti (meno di 8 W) e una grande durata nel tempo.

Ciascun faretto è alimentato a 12V e viene fornito completo del relativo trasformatore da posizionare ad una distanza di 3,5 m dalla piscina.

### WHITE LED SPOTS

Each DolceVita pool includes the standard supply of one or two white LED spotlights from the Laghetto line (depending on the size chosen) already positioned on the liner that give to the pools impressive light effects, day and night. These spotlights combine high-performance light output with low power consumption (less than 8 W) and great durability.

Each spotlight is powered at 12V and comes complete with its transformer to be positioned at a distance of 3.5m from the pool.

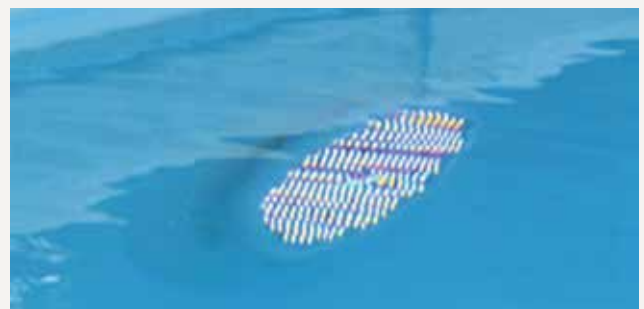

## LA LUCE DI DOLCEVITA ARREDA LA NOTTE !

## DOLCEVITA LIGHT DECORATES THE NIGHT !

# I PARTICOLARI DEL KIT PISCINA

## POOL KIT DETAILS

### SCALA > LADDER



#### SCALE DOLCEVITA

**La linea Dolcevita prevede due differenti tipologie di scala per l'accesso in vasca.**

Le versioni **RATTAN\*** e **NAKED** montano di serie la scaletta "Safety" con parte esterna ribaltabile di sicurezza. Questa può essere sollevata per impedire ai bambini di entrare in piscina nei momenti in cui non è possibile sorvegliarli.

La scala è realizzata con tubolari in acciaio inox AISI316 (tubo Ø 30 mm), lucidati, gradini in plastica bianca e balconcino superiore in legno composito.

**\* Il kit piscina Dolcevita Rattan è comprensivo della scala "Safety" fino ad esaurimento scorte poi verrà sostituita dalla scala "Luxury".**

Le versioni **DIVA** e **DIVA LTI** montano invece una scaletta dedicata, scala "Luxury", realizzata completamente in acciaio inox AISI316 (tubo Ø 43 mm), gradini in acciaio inox con inserti antiscivolo in plastica e balconcino superiore in legno composito. La scala "Luxury" può essere montata anche sui modelli Rattan e Naked.

Disponibile su questa versione un kit di sicurezza in plexiglass per impedire l'accesso in vasca ai più piccoli.

#### LADDERS

**Rattan\*** and **Naked** versions are fitted with a standard ladder that includes a safety flip-open part. This has been created to prevent uncorrect children behaviors while they are not supervised.

The ladder is made of polished AISI316 stainless steel tubulars (30 mm tube), white plastic steps and an upper step in composite wood.

**\* The Dolcevita Rattan pool kit includes the standard safety ladder model until stocks last, then it will be replaced by the luxury Diva model.**

**Diva** and **Diva LTI** versions have a dedicated ladder made of AISI316 stainless steel (43 mm tube), stainless steel steps with non-slip plastic insert and an upper step in composite wood. The "Luxury" ladder can also be fitted in Rattan and Naked versions.

A plexiglass safety kit is available on these versions to prevent uncorrect children behaviors.



**SAFETY**  
ladder



**LUXURY**  
ladder



**SAFETY**  
KIT  
for  
**LUXURY**  
ladder

## SKIMMER > SKIMMER



### SKIMMER LAGHETTO

**Lo skimmer Piscine Laghetto è fissato alla parete della piscina, ha la testa flottante e lavora a sfioro sull'acqua, garantendone così un alto grado di pulizia costante nel tempo.**

Dotato di cestello prefiltro il suo pescaggio, a 360 gradi, permette la migliore pulizia possibile della piscina con performance superiori agli skimmer a parete.

L'escursione della testa flottante in altezza permette una grande flessibilità nel riempimento vasca, evitando così che possa inglobare aria e bloccare la pompa dell'impianto di filtrazione.

Lo skimmer è inoltre dotato di una serie di accorgimenti anti-intrappolamento e anti risucchio per la massima sicurezza di tutti i bagnanti.

### LAGHETTO SKIMMER

The Piscine Laghetto skimmer is fixed to the pool wall, it has a floating head and works by skimming over the water, thus guaranteeing a high degree of constant cleanliness over time.

Equipped with a pre-filter basket, its 360-degree draught allows the best possible cleaning of the pool with superior performance to wall-mounted skimmers.

The excursion of the floating head in height allows great flexibility in filling the pool, preventing it from drawing air and blocking the filtration system pump. It is also equipped with a series of anti-trapping and anti-sucking devices for maximum safety of all bathers.

## KIT ASPIRAFANGO > VACUUM CLEANER

### KIT ASPIRAFANGO

La pulizia del vostro specchio d'acqua è fondamentale nella gestione della piscina.

Per questo Piscine Laghetto ha dotato ogni DolceVita di un kit aspirafango da applicare allo skimmer per garantire una perfetta pulizia del fondo.

È costituito da una testa aspirante, manici in alluminio modulare e tubazioni galleggianti dimensionate in base allo specchio acqua della vasca.

### VACUUM CLEANER

Cleaning your pool is essential.

That's why Piscine Laghetto has equipped each DolceVita with a vacuum cleaner kit to attach to the skimmer to ensure perfect bottom cleaning.

It consists of a suction head, modular aluminium handles and floating hoses sized according to the pool's water mirror.



# I PARTICOLARI DEL KIT PISCINA

## POOL KIT DETAILS

### FILTRAZIONE > FILTRATION

#### FILTRAZIONE

Piscine Laghetto, facendo parte del Gruppo Fluidra, (azienda leader nel mondo per la fornitura di attrezzatura per le piscine), sfrutta l'esperienza della casa madre per equipaggiare le proprie vasche con **impianti di filtrazione e depurazione dall'indiscussa qualità costruttiva e dalle migliori performance sul mercato.**

Consapevoli dell'importanza della qualità dell'acqua, gli impianti di filtrazione Dolcevita sono adeguatamente dimensionati per garantire il massimo grado di pulizia e igiene.

**Sono disponibili due tipologie di filtrazione: a sabbia e a cartuccia.**





#### FILTRATION

As part of the Fluidra Group, one of the world's leading suppliers of swimming pool equipment, Piscine Laghetto takes advantage of the parent company's experience to equip its pools with filtration and purification systems of undisputed construction quality and top market performance.

Aware of the importance of water quality Dolcevita's filtration systems are adequately dimensioned to guarantee maximum cleanliness and hygiene.

Two types of filtration are available: sand and cartridge.

	n° skimmer skimmer	n° mandate outlet	FILTRO / FILTER	POMPA / PUMP					
			tipo type	carico sabbia sand load	prefiltro prefilter	portata max max flow rate	potenza power	prevalenza max max prevalence	rumorosità max max noise
	1	1	<b>filtro a sabbia Cantabric Ø500 mm , portata 9 m³/h stampato ad iniezione con valvola top a 6 vie.</b>  Cantabric Ø500 mm injection-moulded sand filter with 6-way top valve	100 Kg	<b>si</b> yes	19 m³/h	0,77 kW	13,1 m	78 db
	2	2	<b>filtro a sabbia Cantabric Ø600 mm , portata 14 m³/h stampato ad iniezione con valvola top a 6 vie</b>  Cantabric Ø600 mm injection-moulded sand filter with 6-way top valve	150 Kg	<b>si</b> yes	22 m³/h	1,1 kW	16 m	78 db
	1	1	<b>filtro a cartuccia Zodiac, superficie filtrante 9.3 m², capacità filtrante 15-20 micron</b>  Zodiac cartridge filter, filter surface area 9.3 m², filter capacity 15-20 microns	-	no	11,4 m³/h	0,8 kW	11 m	75 db

# GLI ACCESSORI

## ACCESSORIES

**OPTIONAL**

### **KIT BASAMENTO** **> BASEMENT KIT**

**OPTIONAL**

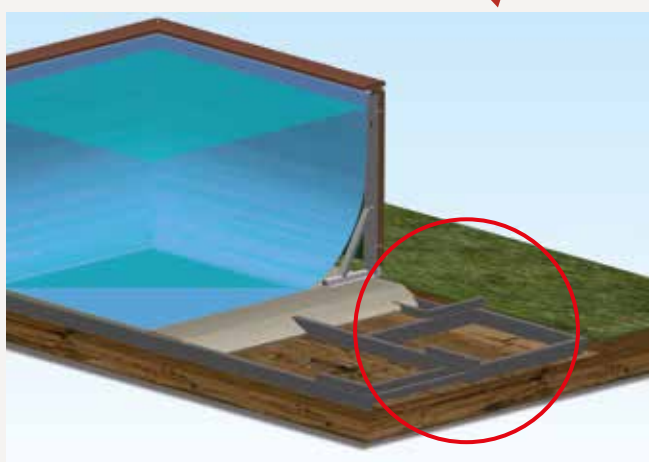

#### **BASAMENTO PER MONTAGGIO SENZA CEMENTO**

Grazie a questo speciale basamento in acciaio zincato e verniciato a polvere è possibile montare la piscina direttamente sul terreno, senza realizzare la soletta in cemento.

Il basamento può essere accompagnato da un certificato di mobilità che dichiara la facile rimozione della piscina stessa, per un uso anche solo stagionale.

#### **BASEMENT FOR DIRECT ASSEMBLY ON THE GROUND**

Thanks to the galvanised steel basement kit painted with powders, it is possible to install the pool directly on the ground, without concrete slab.

It is possible to issue a mobility certificate in which is declared that the pool is easy to be removed, using it just for a seasonal purpose.



### **KIT FISSAGGIO ALLINEAMENTO** **> ALIGNMENT FIXING KIT**

**OPTIONAL**

#### **KIT FISSAGGIO ALLINEAMENTO**

Il kit ha la funzione di facilitare il montaggio e l'allineamento della struttura di DolceVita, evitando i normali assestamenti che avvengono durante il riempimento della vasca e vincolando così in modo permanente l'assetto della piscina.

Con l'utilizzo del Kit Fissaggio e Allineamento non sarà più necessario procedere alla regolazione delle altezze e delle pendenze della struttura, come normalmente avviene senza l'utilizzo di questo accessorio.

Risulta essere d'obbligo il suo utilizzo nella situazione in cui un lato della piscina non sia accessibile all'operatore, ad esempio nel caso in cui la piscina venga montata adiacente a un muro o, più in generale, in ambiente ristretto.

#### **ALIGNMENT FIXING KIT**

The alignment fixing kit function is to facilitate the assembly and alignment of the DolceVita structure, avoiding the normal settlements that happen during filling operations, giving a permanent asset.

With the use of the Fixing and Alignment Kit it will no longer be necessary to adjust the heights and slopes of the structure, as is normally done without the use of this accessory.

Indispensable in situations where one side of the pool is not accessible to the operator, for example in the case of DolceVita installed against a wall or, more generally, in a confined environment.



# GLI ACCESSORI

## ACCESSORIES

**OPTIONAL**

### **KIT NUOTO CONTRO CORRENTE** **> COUNTERCURRENT SWIMMING KIT**



**OPTIONAL**

#### **SISTEMA NUOTO CONTRO CORRENTE**

Accessorio disponibile solo per i modelli Dolcevita Diva e Diva LTI (Per piscine con larghezza di 3 o 4 m).

Il nuoto contro corrente, facilmente installabile, è stato creato da Piscine Laghetto per permettere l'attività natatoria anche in vasche di dimensioni ridotte.

Il Kit Nuoto Contro Corrente è composto da due pompe da 1560W l'una (portata max 36 m<sup>3</sup>/h, prevalenza 12.8 m), quattro passanti di aspirazione con griglia di protezione, 2 bocchette NCC con specifiche flange per il montaggio sui liner Dolcevita più i raccordi e le tubazioni necessarie per posizionare la pompa a 3,5 m dalla piscina come richiesto dalle normative di sicurezza.

Sono compresi nel kit il pulsante pneumatico per l'accensione e uno specifico quadro elettrico per il comando e la temporizzazione delle pompe.

#### **COUNTERCURRENT SWIMMING KIT**

This accessory is available for Dolcevita Diva and Diva LTI models only. (just for pools with width of 3/4 meters)

The counter current kit has been specifically created for Piscine Laghetto. It is easy to install and allows swimming even in pool with small dimensions.

The counter current kit is composed by: no. 2 pumps 1560W (max-flow rate 36m<sup>3</sup>/h, head 12,8m), suction fittings with protective grid, no. 2 NCC nozzles with specific flanges to install it on the Dolcevita liners.

As per safety regulation, fittings and piping have to be positioned 3.5m away from pool.

The kit includes the pneumatic button for switching on and a specific switch-board to control and regulate the pumps timing.

### **KIT IDROMASSAGGIO A 7 GETTI** **> 7-JET HYDROMASSAGE KIT**

#### **KIT IDROMASSAGGIO A 7 GETTI**

**OPTIONAL**

Disponibile per i modelli Dolcevita Rattan, Diva e Diva LTI (Per piscine con larghezza di 3 o 4 m).

Sviluppato appositamente per rispondere alla domanda sempre crescente di soluzioni per il benessere della persona, il kit Idromassaggio è composto da una pompa 900W (portata max 18m<sup>3</sup>/h, prevalenza 13.5 m), due passanti di aspirazione con griglia di protezione, 7 bocchette idromassaggio con specifiche flange per il montaggio su liner Dolcevita, raccordi e tubazioni necessarie per posizionare la pompa a 3,5 m dalla piscina come richiesto dalle normative di sicurezza.

È compreso nel kit il pulsante pneumatico per l'accensione e uno specifico quadro elettrico per il comando e la temporizzazione della pompa.

#### **7-JET HYDROMASSAGE KIT**

This accessory is available for Dolcevita Rattan, Diva and Diva LTI models. (just for pools with width of 3/4 meters)

It has been developed to meet the increasing demand for wellness.

The counter current kit is composed of: no. 2 pumps of 900" (max flow rate 18m<sup>3</sup>/h, head 13.5m), no. 2 suction fittings with protective grid, no. 7 counter current nozzles with specific flanges to install it on Dolcevita liners.

As per safety regulation, fitting and piping have to be positioned 3.5m away from the pool.

The kit includes the pneumatic button for switching on and a specific switch-board to control and regulate the pumps timing.



## COPRIPISCINA > POOL COVER

OPTIONAL



### COPRIPISCINA INVERNALE

Il telo di copertura invernale Light System Plus (di colore verde/nero) con tiranti elastici permette la chiusura ermetica della piscina per tutti i mesi in cui non viene utilizzata. L'utilizzo del copripiscina, unitamente all'uso di corretti prodotti chimici, permette la giusta conservazione dell'acqua contenuta in vasca.

### WINTER POOL COVER

The pool winter cover "Light System Plus" (in green/black colors) is equipped with elastic cords rod that allow to close hermetically the pool when not in use. This accessory, jointly with correct chemical products, preserves the water status during winter period.

OPTIONAL



### COPRIPISCINA ESTIVO

Il telo di copertura isotermico permette di ridurre lo scambio di calore giorno/notte e di conservare meglio la temperatura accumulata durante il giorno. Può essere lasciato galleggiare sullo specchio d'acqua anche durante il giorno, dato che il materiale permette il passaggio dei raggi solari. Questo telo di copertura viene fornito bordato.

### SUMMER POOL COVER

The isothermal cover reduces the day/night heat exchange and helps to maintain the water temperature. It can also be left floating on the water during the day, because its fabric allows sunlight to pass through. Isothermal cover for DolceVita is edged for a better finish.

RATTAN

PAG 24

DIVA

PAG 28

DIVA LTI

PAG 32

NAKED

PAG 36

I KIT DOLCEVITA  
THE KITS

**5** years  
WARRANTY

STRUTTURA E TELO  
STRUCTURE AND LINER

ACCESSORI  
ACCESSORIES

**2** years  
WARRANTY

# RATTAN

## KIT PISCINA

POOL KIT

=

1 + 2 + 3 + 4 + 5 +  
6 + 7 + 8 + 9 + 10



**1**  
Telo interno vasca. Pool liner.



white



beige

**5**  
Pannelli esterni fibra sintetica intrecciata.

Exterior panels handwoven fiber.



coffee



grey

**10**  
Bordo in ecodegno per piscine Dolcevita.

Dolcevita Composite Wood Top Edge.



Tobacco



Ardesia

**2**  
Struttura interna.  
Internal structure.



**3**  
impianto di filtrazione (come da tabella).  
**ATTENZIONE: L'IMPIANTO DI FILTRAZIONE  
NON COMPRENDE IL QUADRO ELETTRICO.**

Filtration System (as in the diagram).

Attention: the filtration system doesn't include the switchboard.



Filtrazione a sabbia AstralPool  
AstralPool sand filters



Filtrazione a cartuccia Zodiac  
Zodiac cartridge filters

**4**  
Faretto a Led ad alta resa luminosa:  
n. 1 faretto sino alla misura 36  
n. 2 faretti dalla misura 37  
(posizione standard - v. pag. 57).

Hight brightness LED spotlight:

n. 1 Spot until model 36 / n. 2 Spots from model 37  
(standard placement - see page 57).

**6**  
Sistema aspirafango per pulizia fondo.  
Vacuum cleaner system.

**7**  
Supporti pannelli in legno e angoli in  
Rattan.  
Wooden panel supports and wicker corner pieces

**8**  
Sistema troppo pieno.  
Overflow system.

**OPTIONAL**

Per Dolcevita Rattan sono disponibili  
molti accessori.  
Per maggiori informazioni sfoglia le  
pagine dedicate.

Many accessories available for Rattan Dolcevita.  
For more information please browse the  
designated pages.

PAG 40



**9**  
**\*\* Il kit piscina Dolcevita Rattan è comprensivo di scala  
di sicurezza standard (SAFETY) fino ad esaurimento scorte.  
La scala in dotazione verrà poi sostituita dalla scala  
LUXURY.**

\*\* The Dolcevita Rattan pool kit includes the standard ladder (SAFETY)  
while stocks last. The supplied ladder will then be replaced by the LUXURY  
ladder.





SPECCHIO ACQUA (INGOMBRO TOT.) WATER SIZE (TOTAL ENCUMBRANCE)	IMPIANTO DI FILTRAZIONE / FILTERING SYSTEM	COLORE / COLOUR	CODICE / CODE
<b>24</b>  <b>2,00</b> <b>X</b> <b>4,00</b>  h.1,20 m (2,40 x 4,40)	 <b>SABBIA DA 10 m<sup>3</sup> h</b> <b>1 SKIMMER</b> 1 SKIMMER 10 m <sup>3</sup> h SAND FILTERING SYSTEM	white - coffee 	<b>XC24BICFS10BR</b>
		white - grey 	<b>XC24BIGRS10BR</b>
		beige - coffee 	<b>XC24BECFS10BR</b>
		beige - grey 	<b>XC24BEGRS10BR</b>
	 <b>CARTUCCIA DA 11 m<sup>3</sup> h</b> <b>1 SKIMMER</b> 1 SKIMMER 11 m <sup>3</sup> h CARTRIDGE FILTERING SYSTEM	white - coffee 	<b>XC24BICFC11BR</b>
		white - grey 	<b>XC24BIGRC11BR</b>
		beige - coffee 	<b>XC24BECFC11BR</b>
		beige - grey 	<b>XC24BEGRC11BR</b>
<b>25</b>  <b>2,00</b> <b>X</b> <b>5,00</b>  h.1,20 m (2,40 x 5,40)	 <b>SABBIA DA 10 m<sup>3</sup> h</b> <b>1 SKIMMER</b> 1 SKIMMER 10 m <sup>3</sup> h SAND FILTERING SYSTEM	white - coffee 	<b>XC25BICFS10BR</b>
		white - grey 	<b>XC25BIGRS10BR</b>
		beige - coffee 	<b>XC25BECFS10BR</b>
		beige - grey 	<b>XC25BEGRS10BR</b>
	 <b>CARTUCCIA DA 11 m<sup>3</sup> h</b> <b>1 SKIMMER</b> 1 SKIMMER 11 m <sup>3</sup> h CARTRIDGE FILTERING SYSTEM	white - coffee 	<b>XC25BICFC11BR</b>
		white - grey 	<b>XC25BIGRC11BR</b>
		beige - coffee 	<b>XC25BECFC11BR</b>
		beige - grey 	<b>XC25BEGRC11BR</b>
<b>35</b>  <b>3,00</b> <b>X</b> <b>5,00</b>  h.1,20 m (3,40 x 5,40)	 <b>SABBIA DA 10 m<sup>3</sup> h</b> <b>1 SKIMMER</b> 1 SKIMMER 10 m <sup>3</sup> h SAND FILTERING SYSTEM	white - coffee 	<b>XC35BICFS10BR</b>
		white - grey 	<b>XC35BIGRS10BR</b>
		beige - coffee 	<b>XC35BECFS10BR</b>
		beige - grey 	<b>XC35BEGRS10BR</b>
	 <b>CARTUCCIA DA 11 m<sup>3</sup> h</b> <b>1 SKIMMER</b> 1 SKIMMER 11 m <sup>3</sup> h CARTRIDGE FILTERING SYSTEM	white - coffee 	<b>XC35BICFC11BR</b>
		white - grey 	<b>XC35BIGRC11BR</b>
		beige - coffee 	<b>XC35BECFC11BR</b>
		beige - grey 	<b>XC35BEGRC11BR</b>

ATTENZIONE: Le gradazioni di colore potrebbero subire variazioni. ATTENTION: Colour shades may vary.

SPECCHIO ACQUA (INGOMBRO TOT.) WATER SIZE (TOTAL ENCUMBRANCE)	IMPIANTO DI FILTRAZIONE / FILTERING SYSTEM	COLORE / COLOUR	CODICE / CODE	
<b>36</b>  <b>3,00</b> <b>x</b> <b>6,00</b>  <b>h.1,20 m</b> (3,40 x 6,40)	 <b>SABBIA DA 10 m³ h</b> <b>1 SKIMMER</b> 1 SKIMMER 10 m³ h SAND FILTERING SYSTEM	white - coffee 	<b>XC36BICFS10BR</b>	
		white - grey 	<b>XC36BIGRS10BR</b>	
	 <b>CARTUCCIA DA 11 m³ h</b> <b>1 SKIMMER</b> 1 SKIMMER 11 m³ h CARTRIDGE FILTERING SYSTEM	beige - coffee 	<b>XC36BECFS10BR</b>	
		beige - grey 	<b>XC36BEGRS10BR</b>	
		white - coffee 	<b>XC36BICFC11BR</b>	
		white - grey 	<b>XC36BIGRC11BR</b>	
 <b>SABBIA DA 10 m³ h</b> <b>1 SKIMMER</b> 1 SKIMMER 10 m³ h SAND FILTERING SYSTEM	 <b>CARTUCCIA DA 11 m³ h</b> <b>1 SKIMMER</b> 1 SKIMMER 11 m³ h CARTRIDGE FILTERING SYSTEM	beige - coffee 	<b>XC36BECFC11BR</b>	
		beige - grey 	<b>XC36BEGRC11BR</b>	
		white - coffee 	<b>XC37BICFS10BR</b>	
		white - grey 	<b>XC37BIGRS10BR</b>	
	<b>37</b>  <b>3,00</b> <b>x</b> <b>7,00</b>  <b>h.1,20 m</b> (3,40 x 7,40)	<b>SABBIA DA 10 m³ h</b> <b>1 SKIMMER</b> 1 SKIMMER 10 m³ h SAND FILTERING SYSTEM	beige - coffee 	<b>XC37BECFS10BR</b>
			beige - grey 	<b>XC37BEGRS10BR</b>
<b>48</b>  <b>4,00 x 8,00</b> <b>h.1,20 m</b> (4,40 x 8,40)	 <b>SABBIA DA 10 m³ h</b> <b>1 SKIMMER</b> 1 SKIMMER 10 m³ h SAND FILTERING SYSTEM	white - coffee 	<b>XC37BICFC11BR</b>	
		white - grey 	<b>XC37BIGRC11BR</b>	
		beige - coffee 	<b>XC37BECFC11BR</b>	
		beige - grey 	<b>XC37BEGRC11BR</b>	
	<b>49</b>  <b>4,00 x 9,00</b> <b>h.1,20 m</b> (4,40 x 9,40)	 <b>SABBIA DA 10 m³ h</b> <b>1 SKIMMER</b> 1 SKIMMER 10 m³ h SAND FILTERING SYSTEM	white - coffee 	<b>XC48BICFS10BR</b>
			white - grey 	<b>XC48BIGRS10BR</b>
<b>49</b>  <b>4,00 x 9,00</b> <b>h.1,20 m</b> (4,40 x 9,40)	 <b>SABBIA DA 15 m³ h</b> <b>2 SKIMMER</b> 2 SKIMMERS 15 m³ h SAND FILTERING SYSTEM	beige - coffee 	<b>XC48BECFS10BR</b>	
		beige - grey 	<b>XC48BEGRS10BR</b>	
		white - coffee 	<b>XC49BICFS15BR</b>	
		white - grey 	<b>XC49BIGRS15BR</b>	
<b>49</b>  <b>4,00 x 9,00</b> <b>h.1,20 m</b> (4,40 x 9,40)	 <b>SABBIA DA 15 m³ h</b> <b>2 SKIMMER</b> 2 SKIMMERS 15 m³ h SAND FILTERING SYSTEM	beige - coffee 	<b>XC49BECFS15BR</b>	
		beige - grey 	<b>XC49BEGRS15BR</b>	

ATTENZIONE: Le gradazioni di colore potrebbero subire variazioni. ATTENTION: Colour shades may vary.



**5** years  
WARRANTY

STRUTTURA E TELO  
STRUCTURE AND LINER

ACCESSORI  
ACCESSORIES

**2** years  
WARRANTY

# DIVA

## KIT PISCINA

POOL KIT

=

1 + 2 + 3 + 4 + 5 +  
6 + 7 + 8 + 9



**1**  
Telo interno vasca. Pool liner.



white



beige

**5**  
Pannellatura con bordo integrato.  
Panels with integrated top edge.



Laghetto white

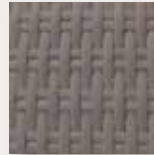

grey



**2**  
Struttura interna.  
Internal structure.



**6**  
Sistema aspirafango per pulizia fondo.  
Vacuum cleaner system.

**3**  
impianto di filtrazione (come da tabella).  
**ATTENZIONE: L'IMPIANTO DI FILTRAZIONE  
NON COMPRENDE IL QUADRO ELETTRICO.**

Filtration System (as in the diagram).  
Attention: the filtration system doesn't include the  
switchboard.



Filtrazione a sabbia AstralPool  
AstralPool sand filters



Filtrazione a cartuccia Zodiac  
Zodiac cartridge filters

**7**  
Supporti pannelli in acciaio.  
Steel panels-supports.

**8**  
Sistema troppo pieno.  
Overflow system.

**9**  
Scala lusso per Dolcevita Diva.  
Luxury ladder specific for Diva version.































**OPTIONAL**



















Per Dolcevita Diva sono disponibili molti  
accessori.  
Per maggiori informazioni sfoglia le  
pagine dedicate.

Many accessories available for Diva Dolcevita.  
For more information please browse the  
designated pages.

PAG 40

SPECCHIO ACQUA (INGOMBRO TOT.) WATER SIZE (TOTAL ENCUMBRANCE)	IMPIANTO DI FILTRAZIONE / FILTERING SYSTEM	COLORE / COLOUR	CODICE / CODE
<b>24</b>  <b>2,00</b> <b>X</b> <b>4,00</b>  <b>h.1,20 m</b> (2,40 x 4,40)	 <b>SABBIA DA 10 m<sup>3</sup> h</b> <b>1 SKIMMER</b> 1 SKIMMER 10 m <sup>3</sup> h SAND FILTERING SYSTEM	white - grey 	<b>XC24BIGRS10D</b>
		white - L. white 	<b>XC24BIBIS10D</b>
		beige - grey 	<b>XC24BEGRS10D</b>
		beige - L. white 	<b>XC24BEBIS10D</b>
	 <b>CARTUCCIA DA 11 m<sup>3</sup> h</b> <b>1 SKIMMER</b> 1 SKIMMER 11 m <sup>3</sup> h CARTRIDGE FILTERING SYSTEM	white - grey 	<b>XC24BIGRC11D</b>
		white - L. white 	<b>XC24BIBIC11D</b>
		beige - grey 	<b>XC24BEGRC11D</b>
		beige - L. white 	<b>XC24BEBIC11D</b>
<b>25</b>  <b>2,00</b> <b>X</b> <b>5,00</b>  <b>h.1,20 m</b> (2,40 x 5,40)	 <b>SABBIA DA 10 m<sup>3</sup> h</b> <b>1 SKIMMER</b> 1 SKIMMER 10 m <sup>3</sup> h SAND FILTERING SYSTEM	white - grey 	<b>XC25BIGRS10D</b>
		white - L. white 	<b>XC25BIBIS10D</b>
		beige - grey 	<b>XC25BEGRS10D</b>
		beige - L. white 	<b>XC25BEBIS10D</b>
	 <b>CARTUCCIA DA 11 m<sup>3</sup> h</b> <b>1 SKIMMER</b> 1 SKIMMER 11 m <sup>3</sup> h CARTRIDGE FILTERING SYSTEM	white - grey 	<b>XC25BIGRC11D</b>
		white - L. white 	<b>XC25BIBIC11D</b>
		beige - grey 	<b>XC25BEGRC11D</b>
		beige - L. white 	<b>XC25BEBIC11D</b>
<b>35</b>  <b>3,00</b> <b>X</b> <b>5,00</b>  <b>h.1,20 m</b> (3,40 x 5,40)	 <b>SABBIA DA 10 m<sup>3</sup> h</b> <b>1 SKIMMER</b> 1 SKIMMER 10 m <sup>3</sup> h SAND FILTERING SYSTEM	white - grey 	<b>XC35BIGRS10D</b>
		white - L. white 	<b>XC35BIBIS10D</b>
		beige - grey 	<b>XC35BEGRS10D</b>
		beige - L. white 	<b>XC35BEBIS10D</b>
	 <b>CARTUCCIA DA 11 m<sup>3</sup> h</b> <b>1 SKIMMER</b> 1 SKIMMER 11 m <sup>3</sup> h CARTRIDGE FILTERING SYSTEM	white - grey 	<b>XC35BIGRC11D</b>
		white - L. white 	<b>XC35BIBIC11D</b>
		beige - grey 	<b>XC35BEGRC11D</b>
		beige - L. white 	<b>XC35BEBIC11D</b>

ATTENZIONE: Le gradazioni di colore potrebbero subire variazioni. ATTENTION: Colour shades may vary.

SPECCHIO ACQUA (INGOMBRO TOT.) WATER SIZE TOTAL ENCUMBRANCE)	IMPIANTO DI FILTRAZIONE / FILTERING SYSTEM	COLORE / COLOUR	CODICE / CODE	
<p><b>36</b></p> <p><b>3,00</b> x <b>6,00</b></p> <p><b>h.1,20 m</b> (3,40 x 6,40)</p>	 <p><b>SABBIA DA 10 m<sup>3</sup> h</b> <b>1 SKIMMER</b> 1 SKIMMER 10 m<sup>3</sup> h SAND FILTERING SYSTEM</p>	white - grey 	<b>XC36BIGRS10D</b>	
		white - L. white 	<b>XC36BIBIS10D</b>	
		beige - grey 	<b>XC36BEGRS10D</b>	
		beige - L. white 	<b>XC36BEBIS10D</b>	
	 <p><b>CARTUCCIA DA 11 m<sup>3</sup> h</b> <b>1 SKIMMER</b> 1 SKIMMER 11 m<sup>3</sup> h CARTRIDGE FILTERING SYSTEM</p>	white - grey 	<b>XC36BIGRC11D</b>	
		white - L. white 	<b>XC36BIBIC11D</b>	
		beige - grey 	<b>XC36BEGRC11D</b>	
		beige - L. white 	<b>XC36BEBIC11D</b>	
<p><b>37</b></p> <p><b>3,00</b> x <b>7,00</b></p> <p><b>h.1,20 m</b> (3,40 x 7,40)</p>	 <p><b>SABBIA DA 10 m<sup>3</sup> h</b> <b>1 SKIMMER</b> 1 SKIMMER 10 m<sup>3</sup> h SAND FILTERING SYSTEM</p>	white - grey 	<b>XC37BIGRS10D</b>	
		white - L. white 	<b>XC37BIBIS10D</b>	
		beige - grey 	<b>XC37BEGRS10D</b>	
		beige - L. white 	<b>XC37BEBIS10D</b>	
	 <p><b>CARTUCCIA DA 11 m<sup>3</sup> h</b> <b>1 SKIMMER</b> 1 SKIMMER 11 m<sup>3</sup> h CARTRIDGE FILTERING SYSTEM</p>	white - grey 	<b>XC37BIGRC11D</b>	
		white - L. white 	<b>XC37BIBIC11D</b>	
		beige - grey 	<b>XC37BEGRC11D</b>	
		beige - L. white 	<b>XC37BEBIC11D</b>	
<p><b>48</b></p> <p><b>4,00 x 8,00</b> <b>h.1,20 m</b> (4,40 x 8,40)</p>	 <p><b>SABBIA DA 10 m<sup>3</sup> h</b> <b>1 SKIMMER</b> 1 SKIMMER 10 m<sup>3</sup> h SAND FILTERING SYSTEM</p>	white - grey 	<b>XC48BIGRS10D</b>	
		white - L. white 	<b>XC48BIBIS10D</b>	
		beige - grey 	<b>XC48BEGRS10D</b>	
		beige - L. white 	<b>XC48BEBIS10D</b>	
	<p><b>49</b></p> <p><b>4,00 x 9,00</b> <b>h.1,20 m</b> (4,40 x 9,40)</p>	 <p><b>SABBIA DA 15 m<sup>3</sup> h</b> <b>2 SKIMMER</b> 2 SKIMMERS 15 m<sup>3</sup> h SAND FILTERING SYSTEM</p>	white - grey 	<b>XC49BIGRS15D</b>
			white - L. white 	<b>XC49BIBIS15D</b>
			beige - grey 	<b>XC49BEGRS15D</b>
			beige - L. white 	<b>XC49BEBIS15D</b>

ATTENZIONE: Le gradazioni di colore potrebbero subire variazioni. ATTENTION: Colour shades may vary.



**5** years  
WARRANTY

STRUTTURA E TELO  
STRUCTURE AND LINER

ACCESSORI  
ACCESSORIES

**2** years  
WARRANTY

# DIVA LTI

## KIT PISCINA

POOL KIT

=

1 + 2 + 3 + 4 + 5 +  
6 + 7 + 8 + 9 + 10



**1**  
Telo interno vasca. Pool liner.



white



beige

**5**  
Pannellatura con bordo integrato.  
Panels with integrated top edge.



Laghetto white

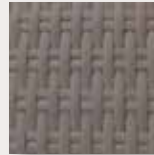

grey

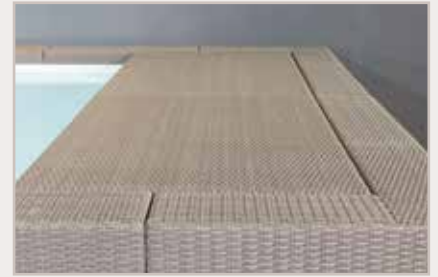

**2**  
Struttura interna.  
Internal structure.

ZMSV.TEC

**6**  
Sistema aspirafango per pulizia fondo.  
Vacuum cleaner system.

**7**  
Supporti pannelli in acciaio.  
Steel panels-supports.

**8**  
Sistema troppo pieno.  
Overflow system.

**9**  
Scala lusso per DolceVita Diva.  
Luxury ladder specific for Diva version.



**10**  
Locale tecnico integrato con sportello di accesso.  
Integrated technical room with access door.

**NOTA:**  
LA COPERTURA DEL LOCALE TECNICO NON E' PORTANTE E NON È CALPESTABILE.

**CAUTION:**  
THE TECHNICAL ROOM IS NOT LOAD-BEARING.  
NO PERSONS ALLOWED ON IT.

































**OPTIONAL**

Per DolceVita Diva LTI sono disponibili molti accessori.  
Per maggiori informazioni sfoglia le pagine dedicate.



Many accessories available for Diva LTI DolceVita.  
For more information please browse the designated pages.

PAG 40



SPECCHIO ACQUA (INGOMBRO TOT.) WATER SIZE (TOTAL ENCUMBRANCE)	IMPIANTO DI FILTRAZIONE / FILTERING SYSTEM	COLORE / COLOUR	CODICE / CODE
<p><b>35</b></p> <p><b>3,00</b> <b>X</b> <b>5,00</b></p> <p>h.1,20 m (3,40 x 6,10)</p>	 <p><b>SABBIA DA 10 m<sup>3</sup> h</b> <b>1 SKIMMER</b> 1 SKIMMER 10 m<sup>3</sup> h SAND FILTERING SYSTEM</p>	white - grey 	<b>XC35BIGRS10DG</b>
		white - L. white 	<b>XC35BIBIS10DG</b>
		beige - grey 	<b>XC35BEGRS10DG</b>
		beige - L. white 	<b>XC35BEBIS10DG</b>
	 <p><b>CARTUCCIA DA 11 m<sup>3</sup> h</b> <b>1 SKIMMER</b> 1 SKIMMER 11 m<sup>3</sup> h CARTRIDGE FILTERING SYSTEM</p>	white - grey 	<b>XC35BIGRC11DG</b>
		white - L. white 	<b>XC35BIBIC11DG</b>
		beige - grey 	<b>XC35BEGRC11DG</b>
		beige - L. white 	<b>XC35BEBIC11DG</b>
<p><b>36</b></p> <p><b>3,00</b> <b>X</b> <b>6,00</b></p> <p>h.1,20 m (3,40 x 7,10)</p>	 <p><b>SABBIA DA 10 m<sup>3</sup> h</b> <b>1 SKIMMER</b> 1 SKIMMER 10 m<sup>3</sup> h SAND FILTERING SYSTEM</p>	white - grey 	<b>XC36BIGRS10DG</b>
		white - L. white 	<b>XC36BIBIS10DG</b>
		beige - grey 	<b>XC36BEGRS10DG</b>
		beige - L. white 	<b>XC36BEBIS10DG</b>
	 <p><b>CARTUCCIA DA 11 m<sup>3</sup> h</b> <b>1 SKIMMER</b> 1 SKIMMER 11 m<sup>3</sup> h CARTRIDGE FILTERING SYSTEM</p>	white - grey 	<b>XC36BIGRC11DG</b>
		white - L. white 	<b>XC36BIBIC11DG</b>
		beige - grey 	<b>XC36BEGRC11DG</b>
		beige - L. white 	<b>XC36BEBIC11DG</b>
<p><b>37</b></p> <p><b>3,00</b> <b>X</b> <b>7,00</b></p> <p>h.1,20 m (3,40 x 8,10)</p>	 <p><b>SABBIA DA 10 m<sup>3</sup> h</b> <b>1 SKIMMER</b> 1 SKIMMER 10 m<sup>3</sup> h SAND FILTERING SYSTEM</p>	white - grey 	<b>XC37BIGRS10DG</b>
		white - L. white 	<b>XC37BIBIS10DG</b>
		beige - grey 	<b>XC37BEGRS10DG</b>
		beige - L. white 	<b>XC37BEBIS10DG</b>
	 <p><b>CARTUCCIA DA 11 m<sup>3</sup> h</b> <b>1 SKIMMER</b> 1 SKIMMER 11 m<sup>3</sup> h CARTRIDGE FILTERING SYSTEM</p>	white - grey 	<b>XC37BIGRC11DG</b>
		white - L. white 	<b>XC37BIBIC11DG</b>
		beige - grey 	<b>XC37BEGRC11DG</b>
		beige - L. white 	<b>XC37BEBIC11DG</b>

ATTENZIONE: Le gradazioni di colore potrebbero subire variazioni. ATTENTION: Colour shades may vary.

SPECCHIO ACQUA (INGOMBRO TOT.) WATER SIZE (TOTAL ENCUMBRANCE)	IMPIANTO DI FILTRAZIONE / FILTERING SYSTEM		COLORE / COLOUR	CODICE / CODE
<p><b>48</b></p> <p><b>4,00 x 8,00</b> h.1,20 m (4,40 x 9,10)</p>		<p><b>SABBIA DA 10 m<sup>3</sup> h</b></p> <p><b>1 SKIMMER</b></p> <p>1 SKIMMER 10 m<sup>3</sup> h</p> <p>SAND FILTERING SYSTEM</p>	<p>white - grey </p> <p>white - L. white </p> <p>beige - grey </p> <p>beige - L. white </p>	<p><b>XC48BIGRS10DG</b></p> <p><b>XC48BIBIS10DG</b></p> <p><b>XC48BEGRS10DG</b></p> <p><b>XC48BEBIS10DG</b></p>
<p><b>49</b></p> <p><b>4,00 x 9,00</b> h.1,20 m (4,40 x 10,10)</p>		<p><b>SABBIA DA 15 m<sup>3</sup> h</b></p> <p><b>2 SKIMMER</b></p> <p>2 SKIMMERS 15 m<sup>3</sup> h</p> <p>SAND FILTERING SYSTEM</p>	<p>white - grey </p> <p>white - L. white </p> <p>beige - grey </p> <p>beige - L. white </p>	<p><b>XC49BIGRS15DG</b></p> <p><b>XC49BIBIS15DG</b></p> <p><b>XC49BEGRS15DG</b></p> <p><b>XC49BEBIS15DG</b></p>

**NOTE**

---

---

---

---

---

---

---

---

---

---

---

---

---

---

---

---

---

---

---

---

---

---

---

---

ATTENZIONE: Le gradazioni di colore potrebbero subire variazioni. ATTENTION: Colour shades may vary.

# photogallery



**5** years  
WARRANTY

STRUTTURA E TELO  
STRUCTURE AND LINER

ACCESSORI  
ACCESSORIES

**2** years  
WARRANTY

# NAKED

## KIT PISCINA

POOL KIT

=

1 + 2 + 3 + 4 + 5 +  
6 + 7 + 8 + 9



**5** Supporti pannelli in legno.  
Wooden panel-supports.

**9** Bordo in ecolegno per piscine DolceVita.  
DolceVita Composite Wood Top Edge.



Tobacco



Ardesia

**6** Sistema aspirafango per pulizia fondo.  
Vacuum cleaner system.

**7** Sistema troppo pieno.  
Overflow system.

**OPTIONAL**

Per DolceVita Naked sono disponibili molti accessori.  
Per maggiori informazioni sfoglia le pagine dedicate.

Many accessories available for Naked DolceVita.  
For more information please browse the designated pages.

PAG 40

## NAKED

IN QUESTA VERSIONE DI DOLCEVITA NON SONO COMPRESI PANNELLATURE.

THIS DOLCEVITA VERSION DOES NOT INCLUDE PANELS



**9** \*\* Il kit piscina DolceVita NAKED è comprensivo di scala di sicurezza standard (SAFETY) fino ad esaurimento scorte. La scala in dotazione verrà poi sostituita dalla scala LUXURY.

\*\* The DolceVita NAKED pool kit includes the standard ladder (SAFETY) while stocks last. The supplied ladder will then be replaced by the LUXURY ladder.



**1** Telo interno vasca. Pool liner.



white



beige

**2** Struttura interna.  
Internal structure.



**3** impianto di filtrazione (come da tabella).  
**ATTENZIONE: L'IMPIANTO DI FILTRAZIONE NON COMPRENDE IL QUADRO ELETTRICO.**

Filtration System (as in the diagram).  
Attention: the filtration system doesn't include the switchboard.



Filtrazione a sabbia AstralPool  
AstralPool sand filters



Filtrazione a cartuccia Zodiac  
Zodiac cartridge filters

**4** Faretto a Led ad alta resa luminosa:  
n. 1 faretto sino alla misura 36  
n. 2 faretti dalla misura 37  
(posizione standard - v. pag. 57).

Hight brightness LED spotlight:  
n. 1 Spot until model 36 / n. 2 Spots from model 37  
(standard placement - see page 57).

SPECCHIO ACQUA (INGOMBRO TOT.) WATER SIZE (TOTAL ENCUMBRANCE)	IMPIANTO DI FILTRAZIONE / FILTERING SYSTEM	COLORE (telo vasca e bordo) COLOUR (liner & edge)	CODICE / CODE
<b>24</b>  <b>2,00</b> <b>X</b> <b>4,00</b>  <b>h.1,20 m</b> (2,40 x 4,40)	 <b>SABBIA DA 10 m<sup>3</sup> h</b> <b>1 SKIMMER</b> 1 SKIMMER 10 m <sup>3</sup> h SAND FILTERING SYSTEM	white - tabacco 	<b>XC24BIS10BN</b>
		white - ardesia 	<b>XC24BIS10BGN</b>
		beige - tabacco 	<b>XC24BES10BN</b>
		beige - ardesia 	<b>XC24BES10BGN</b>
	 <b>CARTUCCIA DA 11 m<sup>3</sup> h</b> <b>1 SKIMMER</b> 1 SKIMMER 11 m <sup>3</sup> h CARTRIDGE FILTERING SYSTEM	white - tabacco 	<b>XC24BIC11BN</b>
		white - ardesia 	<b>XC24BIC11BGN</b>
		beige - tabacco 	<b>XC24BEC11BN</b>
		beige - ardesia 	<b>XC24BEC11BGN</b>
<b>25</b>  <b>2,00</b> <b>X</b> <b>5,00</b>  <b>h.1,20 m</b> (2,40 x 5,40)	 <b>SABBIA DA 10 m<sup>3</sup> h</b> <b>1 SKIMMER</b> 1 SKIMMER 10 m <sup>3</sup> h SAND FILTERING SYSTEM	white - tabacco 	<b>XC25BIS10BN</b>
		white - ardesia 	<b>XC25BIS10BGN</b>
		beige - tabacco 	<b>XC25BES10BN</b>
		beige - ardesia 	<b>XC25BES10BGN</b>
	 <b>CARTUCCIA DA 11 m<sup>3</sup> h</b> <b>1 SKIMMER</b> 1 SKIMMER 11 m <sup>3</sup> h CARTRIDGE FILTERING SYSTEM	white - tabacco 	<b>XC25BIC11BN</b>
		white - ardesia 	<b>XC25BIC11BGN</b>
		beige - tabacco 	<b>XC25BEC11BN</b>
		beige - ardesia 	<b>XC25BEC11BGN</b>
<b>35</b>  <b>3,00</b> <b>X</b> <b>5,00</b>  <b>h.1,20 m</b> (3,40 x 5,40)	 <b>SABBIA DA 10 m<sup>3</sup> h</b> <b>1 SKIMMER</b> 1 SKIMMER 10 m <sup>3</sup> h SAND FILTERING SYSTEM	white - tabacco 	<b>XC35BIS10BN</b>
		white - ardesia 	<b>XC35BIS10BGN</b>
		beige - tabacco 	<b>XC35BES10BN</b>
		beige - ardesia 	<b>XC35BES10BGN</b>
	 <b>CARTUCCIA DA 11 m<sup>3</sup> h</b> <b>1 SKIMMER</b> 1 SKIMMER 11 m <sup>3</sup> h CARTRIDGE FILTERING SYSTEM	white - tabacco 	<b>XC35BIC11BN</b>
		white - ardesia 	<b>XC35BIC11BGN</b>
		beige - tabacco 	<b>XC35BEC11BN</b>
		beige - ardesia 	<b>XC35BEC11BGN</b>

ATTENZIONE: Le gradazioni di colore potrebbero subire variazioni. ATTENTION: Colour shades may vary.

SPECCHIO ACQUA (INGOMBRO TOT.) WATER SIZE (TOTAL ENCUMBRANCE)	IMPIANTO DI FILTRAZIONE / FILTERING SYSTEM	COLORE (telo vasca e bordo) COLOUR (liner & edge)	CODICE / CODE
<h2>36</h2> <p>3,00 x 6,00</p> <p>h.1,20 m (3,40 x 6,40)</p>	 <p><b>SABBIA DA 10 m<sup>3</sup> h</b> <b>1 SKIMMER</b> 1 SKIMMER 10 m<sup>3</sup> h SAND FILTERING SYSTEM</p>	white - tabacco 	<b>XC36BIS10BN</b>
		white - ardesia 	<b>XC36BIS10BGN</b>
		beige - tabacco 	<b>XC36BES10BN</b>
		beige - ardesia 	<b>XC36BES10BGN</b>
	 <p><b>CARTUCCIA DA 11 m<sup>3</sup> h</b> <b>1 SKIMMER</b> 1 SKIMMER 11 m<sup>3</sup> h CARTRIDGE FILTERING SYSTEM</p>	white - tabacco 	<b>XC36BIC11BN</b>
		white - ardesia 	<b>XC36BIC11BGN</b>
		beige - tabacco 	<b>XC36BEC11BN</b>
		beige - ardesia 	<b>XC36BEC11BGN</b>
<h2>37</h2> <p>3,00 x 7,00</p> <p>h.1,20 m (3,40 x 7,40)</p>	 <p><b>SABBIA DA 10 m<sup>3</sup> h</b> <b>1 SKIMMER</b> 1 SKIMMER 10 m<sup>3</sup> h SAND FILTERING SYSTEM</p>	white - tabacco 	<b>XC37BIS10BN</b>
		white - ardesia 	<b>XC37BIS10BGN</b>
		beige - tabacco 	<b>XC37BES10BN</b>
		beige - ardesia 	<b>XC37BES10BGN</b>
	 <p><b>CARTUCCIA DA 11 m<sup>3</sup> h</b> <b>1 SKIMMER</b> 1 SKIMMER 11 m<sup>3</sup> h CARTRIDGE FILTERING SYSTEM</p>	white - tabacco 	<b>XC37BIC11BN</b>
		white - grey 	<b>XC37BIC11BGN</b>
		beige - tabacco 	<b>XC37BEC11BN</b>
		beige - ardesia 	<b>XC37BEC11BGN</b>
<h2>48</h2> <p>4,00 x 8,00 h.1,20 m (4,40 x 8,40)</p>	 <p><b>SABBIA DA 10 m<sup>3</sup> h</b> <b>1 SKIMMER</b> 1 SKIMMER 10 m<sup>3</sup> h SAND FILTERING SYSTEM</p>	white - tabacco 	<b>XC48BIS10BN</b>
		white - ardesia 	<b>XC48BIS10BGN</b>
		beige - tabacco 	<b>XC48BES10BN</b>
		beige - ardesia 	<b>XC48BES10BGN</b>
<h2>49</h2> <p>4,00 x 9,00 h.1,20 m (4,40 x 9,40)</p>	 <p><b>SABBIA DA 15 m<sup>3</sup> h</b> <b>2 SKIMMER</b> 2 SKIMMERS 15 m<sup>3</sup> h SAND FILTERING SYSTEM</p>	white - tabacco 	<b>XC49BIS15BN</b>
		white - ardesia 	<b>XC49BIS15BGN</b>
		beige - tabacco 	<b>XC49BES15BN</b>
		beige - ardesia 	<b>XC49BES15BGN</b>

ATTENZIONE: Le gradazioni di colore potrebbero subire variazioni. ATTENTION: Colour shades may vary.



**OPTIONAL**

## GLI ACCESSORI

### ACCESSORIES

ACCESSORI  
ACCESSORIES **2** years  
WARRANTY

## KIT BASAMENTO PER MONTAGGIO SENZA SOLETTA IN CEMENTO

### STEEL BASEMENT STRUCTURE FOR ASSEMBLY WITHOUT CONCRETE SLAB

**OPTIONAL**

#### CHE COSA È ?

**E' la perfetta soluzione per l'installazione di Dolcevita evitando opere civili. Questo accessorio è posizionato tra il fondo della piscina e il terreno opportunamente preparato.**

E' composto da specifici tubolari e lamiere in acciaio zincato e verniciato a polvere che mantengono rialzato il telo della piscina rispetto al terreno.

Il successivo riempimento della struttura del basamento con sabbia crea una superficie di distribuzione adeguata per il carico soprastante della piscina.

#### QUALI I VANTAGGI ?

Il kit basamento consente l'installazione di Dolcevita anche in territori dove, per normative particolari, non è consentito l'utilizzo di cemento.

È inoltre indicato per installare Dolcevita come piscina temporanea in quanto totalmente smontabile e di conseguenza ad impatto ambientale zero. Un apposito certificato di mobilità può essere fornito a richiesta.

Il kit basamento è assemblato in loco, come la struttura della piscina Dolcevita, e quindi installabile anche in zone ad accesso difficoltoso.

#### QUANDO POSSO INSTALLARLO ?

Il kit basamento è installabile su ogni tipo di terreno previa verifica del vostro ingegnere progettista per scegliere come effettuare al meglio la preparazione del terreno per il montaggio.

Vedi Manuale di montaggio Dolcevita per maggiori informazioni sulla preparazione del terreno.



#### WHAT IS IT ?

It is the perfect solution for installing Dolcevita without any civil works. This accessory is positioned between the bottom of the pool and a suitably prepared ground.

It consists of specific galvanised powder-coated steel tubes and sheets that keep the pool liner elevated above the ground.

The subsequent filling of the base structure with sand creates an adequate distribution surface for the pool load above it.

#### WHAT ARE THE BENEFITS ?

The basement kit permits to install Dolcevita in areas where the use of concrete is not allowed.

It is also suitable for installing Dolcevita as a temporary pool as it can be totally dismantled with zero environmental impact. A specific mobility certificate can be provided on request.

The base kit is assembled on site, like the Dolcevita pool structure. For this reason it can be installed in hard-to-reach areas as well.

#### WHEN CAN I INSTALL IT ?

The basement kit can be installed on any type of ground. It is strictly recommended to ask your design engineer to verify how to prepare the ground for installation at the best.

See Dolcevita assembly instructions for more information on ground preparation.





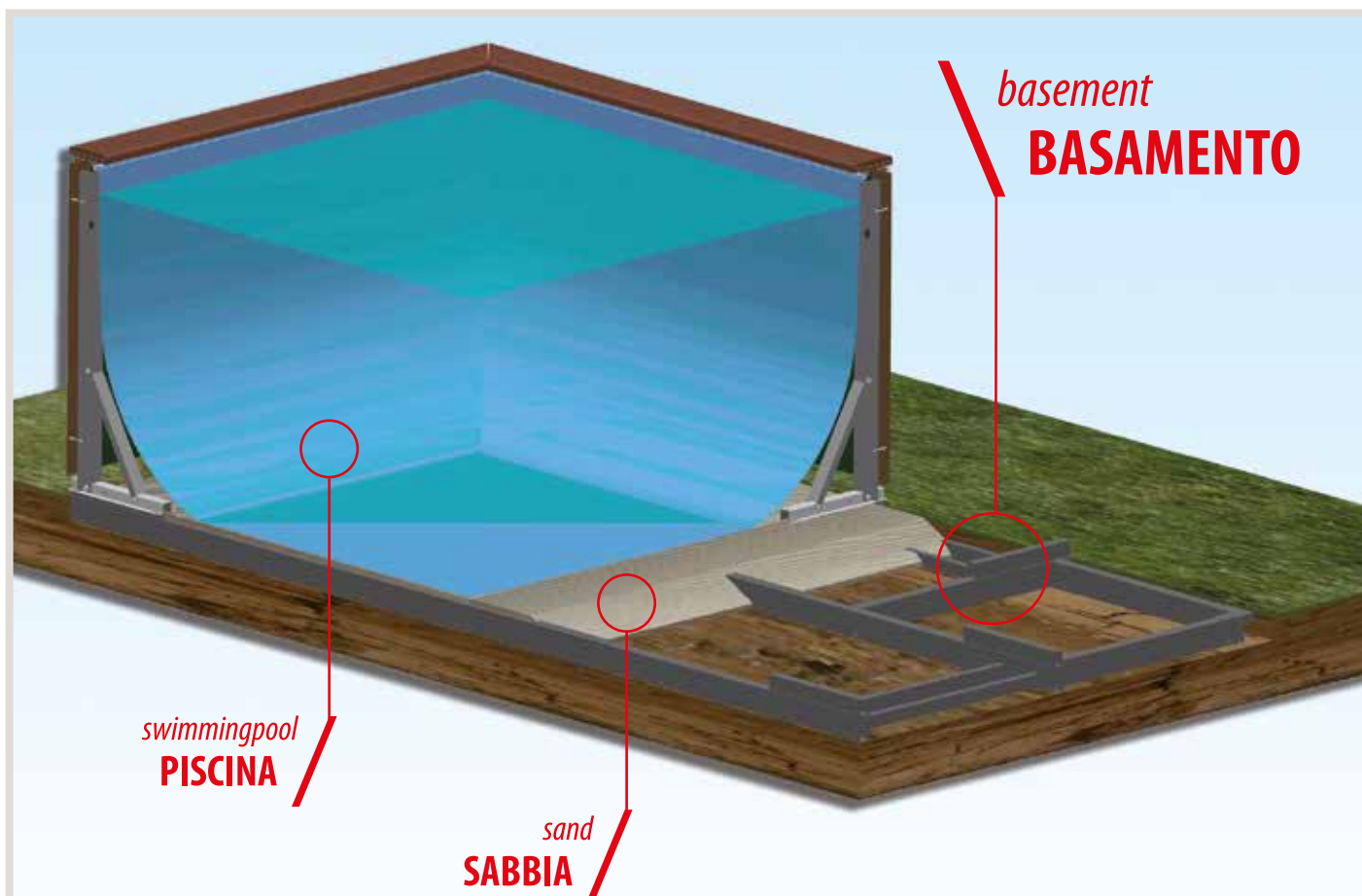

- zero impact installation  
**installazione ad impatto ZERO**
- easy to move and assemble  
**facile da trasportare e montare**
- for installation where no concrete slab can be made  
**per il montaggio dove non è possibile preparare una soletta in C.A.**
- totally removable  
**totalmente smontabile**

SPECCHIO ACQUA WATER SIZE	DESCRIZIONE - DESCRIPTION	CODICE - CODE
<b>24*</b>	<b>KIT PREFABBRICATO IN ACCIAIO PER MONTAGGIO SENZA SOLETTA IN C.A.</b> STEEL BASEMENT STRUCTURE FOR ASSEMBLY WITHOUT CONCRETE SLAB	<b>JDVC24KITTB</b>
<b>25*</b>	<b>KIT PREFABBRICATO IN ACCIAIO PER MONTAGGIO SENZA SOLETTA IN C.A.</b> STEEL BASEMENT STRUCTURE FOR ASSEMBLY WITHOUT CONCRETE SLAB	<b>JDVC25KITTB</b>
<b>35</b>	<b>KIT PREFABBRICATO IN ACCIAIO PER MONTAGGIO SENZA SOLETTA IN C.A.</b> STEEL BASEMENT STRUCTURE FOR ASSEMBLY WITHOUT CONCRETE SLAB	<b>JDVC35KITTB</b>
<b>36</b>	<b>KIT PREFABBRICATO IN ACCIAIO PER MONTAGGIO SENZA SOLETTA IN C.A.</b> STEEL BASEMENT STRUCTURE FOR ASSEMBLY WITHOUT CONCRETE SLAB	<b>JDVC36KITTB</b>
<b>37</b>	<b>KIT PREFABBRICATO IN ACCIAIO PER MONTAGGIO SENZA SOLETTA IN C.A.</b> STEEL BASEMENT STRUCTURE FOR ASSEMBLY WITHOUT CONCRETE SLAB	<b>JDVC37KITTB</b>
<b>48</b>	<b>KIT PREFABBRICATO IN ACCIAIO PER MONTAGGIO SENZA SOLETTA IN C.A.</b> STEEL BASEMENT STRUCTURE FOR ASSEMBLY WITHOUT CONCRETE SLAB	<b>JDVC48KITTB</b>
<b>49</b>	<b>KIT PREFABBRICATO IN ACCIAIO PER MONTAGGIO SENZA SOLETTA IN C.A.</b> STEEL BASEMENT STRUCTURE FOR ASSEMBLY WITHOUT CONCRETE SLAB	<b>JDVC49KITTB</b>
<b>510</b>	<b>KIT PREFABBRICATO IN ACCIAIO PER MONTAGGIO SENZA SOLETTA IN C.A.</b> STEEL BASEMENT STRUCTURE FOR ASSEMBLY WITHOUT CONCRETE SLAB	<b>JDVC510KITTB</b>

\*MISURA DISPONIBILE FINO AD ESAURIMENTO SCORTE. SIZE AVAILABLE WHILE STOCKS LAST.

## KIT FISSAGGIO ALLINEAMENTO > ALIGNMENT FIXING KIT

### CHE COSA È ?

Il kit è composto da particolari di bloccaggio in acciaio inox AISI 304 comprensivi di viteria che permettono di evitare i normali assestamenti (disallineamenti) strutturali di DolceVita, durante la fase di riempimento della piscina.

### QUALI I VANTAGGI ?

Questo kit semplifica e velocizza il montaggio di DolceVita in quanto non sarà più necessario procedere alla regolazione successiva al riempimento come normalmente avviene senza l'utilizzo di questo accessorio.

E' sempre utile, ma diventa indispensabile quando un lato della vasca non è accessibile all'operatore al momento della regolazione delle varie altezze e pendenze della struttura (ad esempio nel caso di DolceVita addossata ad un muro o in ambiente ristretto).

### QUANDO POSSO INSTALLARLO ?

Il montaggio del kit di fissaggio e allineamento è già previsto e predisposto sin dalla struttura rinforzata versione 2014 di DolceVita.

Non può essere montato su vasche già installate (senza che le stesse siano completamente smontate) in quanto è necessario staccare il piede dalla soletta per il serraggio delle viti di montaggio.

Il Kit è adattabile alle strutture DolceVita precedenti la versione 2014, solo smontando completamente la struttura e realizzando in cantiere le specifiche forature.



### WHAT IS IT ?

The alignment fixing kit is an AISI 304 stainless steel locking system. It consists of fasteners that prevent the normal structural misalignment of DolceVita during the filling phase.

### WHAT ARE THE BENEFITS ?

This kit simplifies and speeds up DolceVita assembly, as it won't be necessary to adjust the pool after filling with water. It's installation becomes essential if one side of DolceVita is not accessible to the operator when adjusting the heights and slopes of the structure (e.g. when DolceVita is installed against a wall, or in a confined space).

### WHEN CAN I INSTALL IT ?

It fits with DolceVita structures produced from April 2014 on, without any modification.

You can't add the kit to an assembled pool, unless you dismantle the pool completely.

The alignment fixing kit can be adapted also to DolceVita structures purchased before April 2014. In this case the structure of the pool should be modified on site.

SPECCHIO ACQUA - WATER SIZE	DESCRIZIONE - DESCRIPTION	CODICE - CODE
<b>24</b>	<b>KIT PARTICOLARI IN ACCIAIO INOX PER STABILIZZARE LA STRUTTURA A VASCA VUOTA</b> STAINLESS STEEL COMPONENTS TO STABILIZE THE STRUCTURE OF THE POOL.TO ASSEMBLE ONLY WHEN THE POOL IS EMPTY	JDV24KITAL
<b>25</b>	<b>KIT PARTICOLARI IN ACCIAIO INOX PER STABILIZZARE LA STRUTTURA A VASCA VUOTA</b> STAINLESS STEEL COMPONENTS TO STABILIZE THE STRUCTURE OF THE POOL.TO ASSEMBLE ONLY WHEN THE POOL IS EMPTY	JDV25KITAL
<b>35</b>	<b>KIT PARTICOLARI IN ACCIAIO INOX PER STABILIZZARE LA STRUTTURA A VASCA VUOTA</b> STAINLESS STEEL COMPONENTS TO STABILIZE THE STRUCTURE OF THE POOL.TO ASSEMBLE ONLY WHEN THE POOL IS EMPTY	JDV35KITAL
<b>36</b>	<b>KIT PARTICOLARI IN ACCIAIO INOX PER STABILIZZARE LA STRUTTURA A VASCA VUOTA</b> STAINLESS STEEL COMPONENTS TO STABILIZE THE STRUCTURE OF THE POOL.TO ASSEMBLE ONLY WHEN THE POOL IS EMPTY	JDV36KITAL
<b>37</b>	<b>KIT PARTICOLARI IN ACCIAIO INOX PER STABILIZZARE LA STRUTTURA A VASCA VUOTA</b> STAINLESS STEEL COMPONENTS TO STABILIZE THE STRUCTURE OF THE POOL.TO ASSEMBLE ONLY WHEN THE POOL IS EMPTY	JDV37KITAL
<b>48</b>	<b>KIT PARTICOLARI IN ACCIAIO INOX PER STABILIZZARE LA STRUTTURA A VASCA VUOTA</b> STAINLESS STEEL COMPONENTS TO STABILIZE THE STRUCTURE OF THE POOL.TO ASSEMBLE ONLY WHEN THE POOL IS EMPTY	JDV48KITAL
<b>49</b>	<b>KIT PARTICOLARI IN ACCIAIO INOX PER STABILIZZARE LA STRUTTURA A VASCA VUOTA</b> STAINLESS STEEL COMPONENTS TO STABILIZE THE STRUCTURE OF THE POOL.TO ASSEMBLE ONLY WHEN THE POOL IS EMPTY	JDV49KITAL
<b>510</b>	<b>KIT PARTICOLARI IN ACCIAIO INOX PER STABILIZZARE LA STRUTTURA A VASCA VUOTA</b> STAINLESS STEEL COMPONENTS TO STABILIZE THE STRUCTURE OF THE POOL.TO ASSEMBLE ONLY WHEN THE POOL IS EMPTY	JDV510KITAL

**OPTIONAL**

## MODINA DI TRACCIATURA > TRACING TEMPLATE

### CHE COSA È ?

Strumento utile e versatile che, durante il montaggio, permette all'operatore di avere una mappa precisa dei punti di foratura della soletta e successiva tassellatura.

### WHAT IS IT ?

It is a useful tool for the operator, giving him a precise map of the points to drill on the slab and then dowel.

IMMAGINE - PICTURE	DESCRIZIONE - DESCRIPTION	CODICE - CODE
	<b>MODINA DI TRACCIATURA PER DOLCEVITA (E DOLCEVITA GOLD E BLUESPRING)</b> TRACING TEMPLATE FOR DOLCEVITA (DOLCEVITA GOLD AND BLUESPRING) POOL	JDVMODINA

## KIT NUOTO CONTRO CORRENTE COUNTERCURRENT SWIMMING KIT

OPTIONAL

### CHE COSA È ?

Il Kit Nuoto Contro Corrente è un accessorio composto da due pompe da 1560W l'una (portata max 36 m<sup>3</sup>/h, prevalenza 12.8 m), quattro passanti di aspirazione con griglia di protezione, 2 bocchette NCC con specifiche flange per il montaggio sui liner Dolcevita più raccordi e tubazioni necessarie per posizionare la pompa a 3,5 m dalla piscina come richiesto dalle normative di sicurezza.

Sono compresi nel kit il pulsante pneumatico per l'accensione e uno specifico quadro elettrico per il comando e la temporizzazione delle pompe.

### QUALI I VANTAGGI ?

Questo performante accessorio per il nuoto contro corrente, creato appositamente per Piscine Laghetto, è facilmente installabile e permette l'attività natatoria anche in vasche di dimensioni ridotte.

### QUANDO POSSO INSTALLARLO ?

Disponibile solo per i modelli Dolcevita Diva e Diva LTI.

Per piscine con larghezza di 3 o 4 m.

Posizione standard dell'accessorio in vasca non modificabile (vedi schema a lato).

**Accessorio da ordinare solo unitamente al kit piscina su cui deve essere installato.**

Non ordinabile in un secondo tempo.



### WHAT IS IT ?

The countercurrent swimming kit consists of two 1560W pumps (max. flow rate 36 m<sup>3</sup>/h, head 12.8 m), four suction fittings with protection grid, two nozzles with specific flanges for installation on Dolcevita liners, fittings and piping to place the pump at a distance of 3,5 m from the pool.

A pneumatic switch is included in the kit, as well as a specific switchboard for pump control and timing.

### WHAT ARE THE BENEFITS ?

This high-performance accessory for swimming against the current has been specially studied for Piscine Laghetto. It can be easily installed and gives you the possibility to swim even in small pools.

### WHEN CAN I INSTALL IT ?

You can install it only on Dolcevita Diva and Diva LTI models.

It is studied for pools with a width of 3 or 4 m.

It can be installed only in the standard position shown in the diagram next page.

**It can be ordered only together with the pool kit where it will be installed.**

It cannot be ordered later.

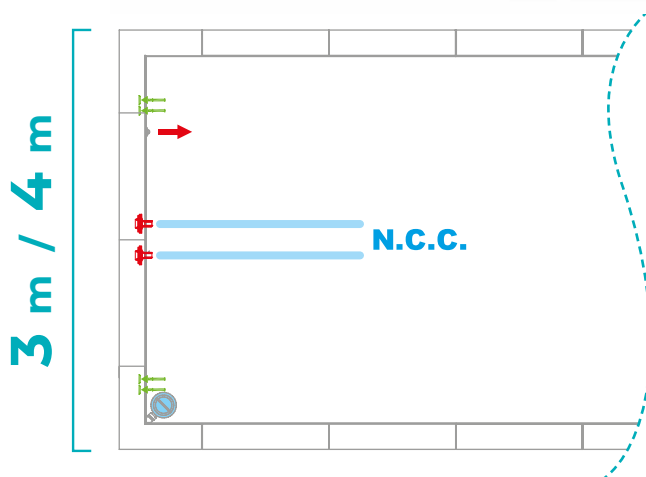

 **POSIZIONE STANDARD ACCESSORIO**  
*Esempio generico rispetto alla posizione dello skimmer.*

ACCESSORY STANDARD POSITION  
*in relation to the position of the skimmer.*

	DESCRIZIONE - DESCRIPTION	CODICE - CODE
<b>3 m.</b>	<p><b>KIT NUOTO CONTRO CORRENTE - PISCINA LATO CORTO LUNGHEZZA 3 M. N. 2 MOTORI, N. 2 IDROGETTI, TUBAZIONI, QUADRO ELETTRICO E COMANDO A DISTANZA CABLATO.</b></p> <p>COUNTERCURRENT SWIMMING KIT FOR POOL WIDTH 3 M            2 MOTORS, 2 WATER JETS, PIPING, SWITCHBOARD AND WIRED REMOTE CONTROL.</p>	<b>JDVKITNCC030</b>
<b>4 m.</b>	<p><b>KIT NUOTO CONTRO CORRENTE - PISCINA LATO CORTO LUNGHEZZA 4 M. N. 2 MOTORI, N. 2 IDROGETTI, TUBAZIONI, QUADRO ELETTRICO E COMANDO A DISTANZA CABLATO.</b></p> <p>COUNTERCURRENT SWIMMING KIT FOR POOL WIDTH 4 M            2 MOTORS, 2 WATER JETS, PIPING, SWITCHBOARD AND WIRED REMOTE CONTROL.</p>	<b>JDVKITNCC040</b>

**ATTENZIONE: PER QUESTO ACCESSORIO AGGIUNGERE ALL'ORDINE ANCHE IL SEGUENTE CODICE**  
 ATTENTION: FOR THESE ACCESSORIES, PLEASE ALSO ADD TO THE ORDER THE FOLLOWING CODE.

	<p><b>FORATURA SPECIALE DEL TELO PER L'ACCESSORIO DA INSTALLARE</b>            SPECIAL DRILLING OF THE LINER FOR THE ACCESSORY TO BE INSTALLED</p>	<b>JFOROFS</b>
--	--	----------------

## KIT IDROMASSAGGIO A 7 GETTI 7-JET HYDROMASSAGE KIT

OPTIONAL

### CHE COSA È ?

Il Kit Idromassaggio è composto da una pompa a 900W (portata max 18m<sup>3</sup>/h, prevalenza 13.5 m), due passanti di aspirazione con griglia di protezione, 7 bocchette idromassaggio con specifiche flange per il montaggio sui liner dolcevita, raccordi e tubazioni necessari per posizionare la pompa a 3,5 m dalla piscina (come richiesto dalle normative di sicurezza).

Sono compresi nel kit il pulsante pneumatico per l'accensione e uno specifico quadro elettrico per il comando e la temporizzazione della pompa.

### QUALI I VANTAGGI ?

Questo performante accessorio è stato appositamente studiato per rispondere alla domanda sempre crescente di soluzioni per il benessere in piscina.

Il kit idromassaggio completa Dolcevita creando un angolo dedicato.

### QUANDO POSSO INSTALLARLO ?

Disponibile per Dolcevita solo per modelli Rattan, Diva e Diva LTI.

Per piscine con larghezza di 3 o 4 m.

Posizione standard dell'accessorio in vasca non modificabile (vedi schema a lato).

**Accessorio da ordinare solo unitamente al kit piscina su cui deve essere installato.**

Non ordinabile in un secondo tempo.



### WHAT IS IT ?

The hydromassage kit is composed of a 900W pump (max. flow rate 18 m<sup>3</sup>/h, head 13.5 m), two suction fittings with protection grid, seven hydro jets with specific flanges for Dolcevita liners, fittings and piping to place the pump at a distance of 3,5 m from the pool

A pneumatic switch is included in the kit as well as a dedicated switchboard for pump control and timing.

### WHAT ARE THE BENEFITS ?

The high-performance hydromassage kit has been specifically designed to integrate wellness solutions in the pool.

It finishes Dolcevita creating a dedicated corner.

### WHEN CAN I INSTALL IT ?

You can install it on Dolcevita Rattan, Diva and Diva LTI models.

It is studied for pools with a width of 3 or 4 m.

It can be installed only in the standard position shown in the diagram next page.

**It can be ordered only together with the pool kit where it will be installed.**

It cannot be ordered later.



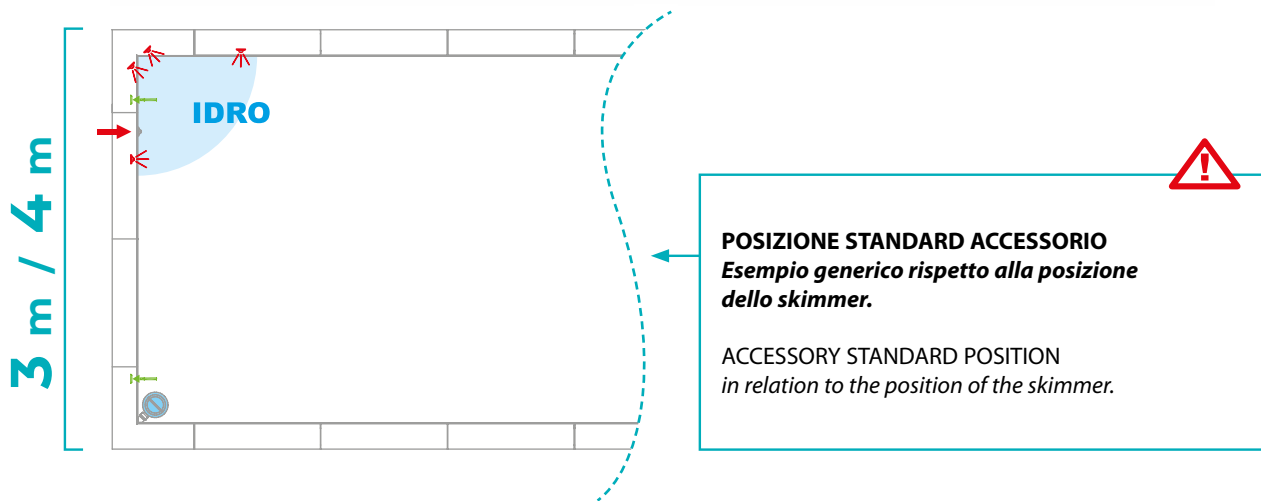
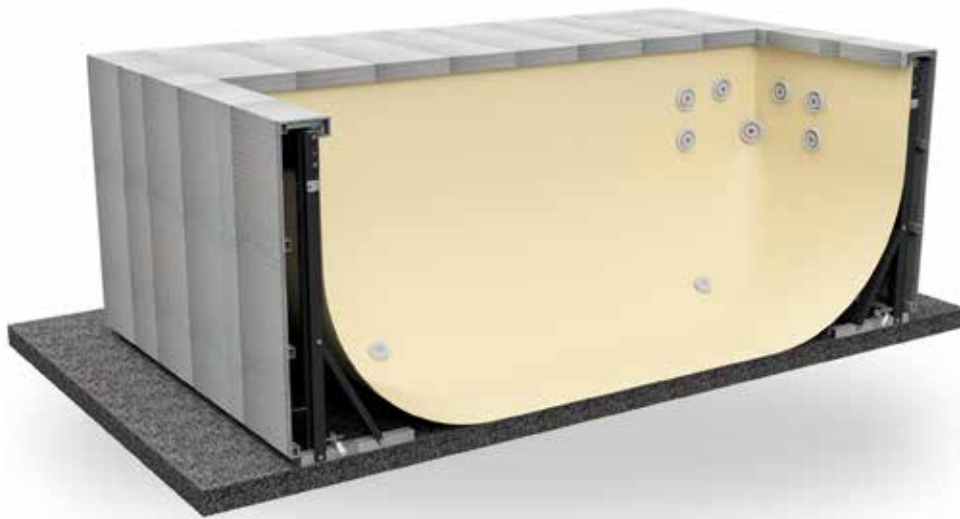

	DESCRIZIONE - DESCRIPTION	CODICE - CODE
<b>3 m.</b>	<p><b>KIT IDROMASSAGGIO A 7 GETTI - PISCINA CON LARGHEZZA 3 M.</b>  <b>N. 1 MOTORE, N. 7 BOCCHETTE, QUADRO ELETTRICO E COMANDO A DISTANZA CABLATO TEMPORIZZATO.</b></p> <p>7 JETS HYDROMASSAGE KIT - SWIMMING POOL WIDTH 3 M            1 MOTOR, 7 NOZZLES, SWITCHBOARD AND TIMED WIRED REMOTE CONTROL.</p>	<b>JDKITIDR0030</b>
<b>4 m.</b>	<p><b>KIT IDROMASSAGGIO A 7 GETTI - PISCINA CON LARGHEZZA 4 M.</b>  <b>N. 1 MOTORE, N. 7 BOCCHETTE, QUADRO ELETTRICO E COMANDO A DISTANZA CABLATO TEMPORIZZATO.</b></p> <p>7 JETS HYDROMASSAGE KIT - SWIMMING POOL WIDTH 4 M            1 MOTOR, 7 NOZZLES, SWITCHBOARD AND TIMED WIRED REMOTE CONTROL.</p>	<b>JDKITIDR0040</b>

**ATTENZIONE: PER QUESTO ACCESSORIO AGGIUNGERE ALL'ORDINE ANCHE IL SEGUENTE CODICE**  
**ATTENTION: FOR THESE ACCESSORIES, PLEASE ALSO ADD TO THE ORDER THE FOLLOWING CODE.**



**FORATURA SPECIALE DEL TELO PER L'ACCESSORIO DA INSTALLARE**  
 SPECIAL DRILLING OF THE LINER FOR THE ACCESSORY TO BE INSTALLED

**JFOROFS**

## COPERTURA INVERNALE DOLCEVITA WINTER POOL COVER FOR DOLCEVITA

**OPTIONAL**

### CHE COSA È ?

Il telo di copertura invernale Light System Plus con tiranti elastici, di colore verde/nero, permette la chiusura ermetica della piscina per tutti i mesi in cui la piscina non viene utilizzata.

L'utilizzo del copripiscina, unitamente all'uso di corretti prodotti chimici, permette la giusta conservazione dell'acqua contenuta in vasca.

### WHAT IS IT ?

The pool winter cover "Light System Plus" (in green/black colors) is equipped with elastic cords rod that allow to close hermetically the pool when not in use.

This accessory, jointly with correct chemical products, preserves the water status during winter period.

SPECCHIO ACQUA WATER SIZE	MISURA TELO FINISHED COVER SIZE	DESCRIZIONE DESCRIPTION	CODICE CODE
<b>24</b>	3,20 x 5,20 m.	<b>TELO DI COPERTURA INVERNALE LSP CON TIRANTI ELASTICI PER DOLCEVITA FUORITERRA</b> LSP WINTER COVER COMPLETE WITH ELASTIC CORDS AND FIXATIONS	JCODVC24GG
<b>25</b>	3,20 x 6,20 m.	<b>TELO DI COPERTURA INVERNALE LSP CON TIRANTI ELASTICI PER DOLCEVITA FUORITERRA</b> LSP WINTER COVER COMPLETE WITH ELASTIC CORDS AND FIXATIONS	JCODVC25GG
<b>35</b>	4,20 x 6,20 m.	<b>TELO DI COPERTURA INVERNALE LSP CON TIRANTI ELASTICI PER DOLCEVITA FUORITERRA</b> LSP WINTER COVER COMPLETE WITH ELASTIC CORDS AND FIXATIONS	JCODVC35GG
<b>36</b>	4,20 x 7,20 m.	<b>TELO DI COPERTURA INVERNALE LSP CON TIRANTI ELASTICI PER DOLCEVITA FUORITERRA</b> LSP WINTER COVER COMPLETE WITH ELASTIC CORDS AND FIXATIONS	JCODVC36GG
<b>37</b>	4,20 x 8,20 m.	<b>TELO DI COPERTURA INVERNALE LSP CON TIRANTI ELASTICI PER DOLCEVITA FUORITERRA</b> LSP WINTER COVER COMPLETE WITH ELASTIC CORDS AND FIXATIONS	JCODVC37GG
<b>48</b>	5,20 x 9,20 m.	<b>TELO DI COPERTURA INVERNALE LSP CON TIRANTI ELASTICI PER DOLCEVITA FUORITERRA</b> LSP WINTER COVER COMPLETE WITH ELASTIC CORDS AND FIXATIONS	JCODVC48GG
<b>49</b>	5,20 x 10,20 m.	<b>TELO DI COPERTURA INVERNALE LSP CON TIRANTI ELASTICI PER DOLCEVITA FUORITERRA</b> LSP WINTER COVER COMPLETE WITH ELASTIC CORDS AND FIXATIONS	JCODVC49GG
<b>510</b>	6,20 x 11,20 m.	<b>TELO DI COPERTURA INVERNALE LSP CON TIRANTI ELASTICI PER DOLCEVITA FUORITERRA</b> LSP WINTER COVER COMPLETE WITH ELASTIC CORDS AND FIXATIONS	JCODVC510GG
<b>LTI 35</b>	4,20 x 7,00 m.	<b>TELO DI COPERTURA INVERNALE LSP CON TIRANTI ELASTICI PER DOLCEVITA DIVA LTI</b> LSP WINTER COVER COMPLETE WITH ELASTIC CORDS AND FIXATIONS FOR DOLCEVITA DIVA LTI	JCODVC35DGGG
<b>LTI 36</b>	4,20 x 8,00 m.	<b>TELO DI COPERTURA INVERNALE LSP CON TIRANTI ELASTICI PER DOLCEVITA DIVA LTI</b> LSP WINTER COVER COMPLETE WITH ELASTIC CORDS AND FIXATIONS FOR DOLCEVITA DIVA LTI	JCODVC36DGGG
<b>LTI 37</b>	4,20 x 9,00 m.	<b>TELO DI COPERTURA INVERNALE LSP CON TIRANTI ELASTICI PER DOLCEVITA DIVA LTI</b> LSP WINTER COVER COMPLETE WITH ELASTIC CORDS AND FIXATIONS FOR DOLCEVITA DIVA LTI	JCODVC37DGGG
<b>LTI 48</b>	5,20 x 10,00 m.	<b>TELO DI COPERTURA INVERNALE LSP CON TIRANTI ELASTICI PER DOLCEVITA DIVA LTI</b> LSP WINTER COVER COMPLETE WITH ELASTIC CORDS AND FIXATIONS FOR DOLCEVITA DIVA LTI	JCODVC48DGGG
<b>LTI 49</b>	5,20 x 11,00 m.	<b>TELO DI COPERTURA INVERNALE LSP CON TIRANTI ELASTICI PER DOLCEVITA DIVA LTI</b> LSP WINTER COVER COMPLETE WITH ELASTIC CORDS AND FIXATIONS FOR DOLCEVITA DIVA LTI	JCODVC49DGGG



## COPERTURA ESTIVA PER DOLCEVITA SUMMER POOL COVER FOR DOLCEVITA

**OPTIONAL**

### CHE COSA È ?

Il telo di copertura isotermico permette di ridurre lo scambio di calore giorno/notte e di conservare meglio la temperatura accumulata durante il giorno. Può essere lasciato galleggiare sullo specchio d'acqua anche durante il giorno, dato che il materiale permette il passaggio dei raggi solari.

Questo telo di copertura viene fornito bordato.

### WHAT IS IT ?

The isothermal cover reduces the day/night heat exchange and helps to maintain the water temperature.

It can be left floating on the water during the day, because its fabric allows sunlight to pass through.

Isothermal cover for DolceVita is edged for a better finish.

SPECCHIO ACQUA WATER SIZE	MISURA TELO COVER TOTAL SIZE	DESCRIZIONE DESCRIPTION	CODICE CODE
<b>24</b>	2,00 x 4,00 m.	<b>COPERTURA ESTIVA ISOTERMICA BORDATA PER DOLCEVITA</b> ISOTHERMAL SUMMER COVER FOR DOLCEVITA	JCOGIDV24GG
<b>25</b>	2,00 x 5,00 m.	<b>COPERTURA ESTIVA ISOTERMICA BORDATA PER DOLCEVITA</b> ISOTHERMAL SUMMER COVER FOR DOLCEVITA	JCOGIDV25GG
<b>35</b>	3,00 x 5,00 m.	<b>COPERTURA ESTIVA ISOTERMICA BORDATA PER DOLCEVITA</b> ISOTHERMAL SUMMER COVER FOR DOLCEVITA	JCOGIDV35GG
<b>36</b>	3,00 x 6,00 m.	<b>COPERTURA ESTIVA ISOTERMICA BORDATA PER DOLCEVITA</b> ISOTHERMAL SUMMER COVER FOR DOLCEVITA	JCOGIDV36GG
<b>37</b>	3,00 x 7,00 m.	<b>COPERTURA ESTIVA ISOTERMICA BORDATA PER DOLCEVITA</b> ISOTHERMAL SUMMER COVER FOR DOLCEVITA	JCOGIDV37GG
<b>48</b>	4,00 x 8,00 m.	<b>COPERTURA ESTIVA ISOTERMICA BORDATA PER DOLCEVITA</b> ISOTHERMAL SUMMER COVER FOR DOLCEVITA	JCOGIDV48GG
<b>49</b>	4,00 x 9,00 m.	<b>COPERTURA ESTIVA ISOTERMICA BORDATA PER DOLCEVITA</b> ISOTHERMAL SUMMER COVER FOR DOLCEVITA	JCOGIDV49GG
<b>510</b>	5,00 x 10,00 m.	<b>COPERTURA ESTIVA ISOTERMICA BORDATA PER DOLCEVITA</b> ISOTHERMAL SUMMER COVER FOR DOLCEVITA	JCOGIDV510GG

## SCHERMO DI SICUREZZA PER SCALA LUXURY SAFETY SCREEN FOR LUXURY LADDER

**OPTIONAL**

### CHE COSA È ?

Questo kit di sicurezza in plexiglass per la scala modello Luxury impedisce l'accesso in vasca ai più piccoli quando non sorvegliati da un adulto.

### WHAT IS IT ?

This plexiglass safety kit for the Luxury ladder prevents children from entering the pool when unsupervised by an adult.

IMMAGINE - PICTURE	DESCRIZIONE - DESCRIPTION	CODICE - CODE
	<b>SCHERMO DI SICUREZZA IN PLEXIGLASS PER SCALA LUXURY</b> PLEXIGLASS KIDS-SAFETY KIT FOR LUXURY LADDER	JSCDVKS

# PESI E MISURE > WEIGHTS & SIZES

## RATTAN

MODELLO MODEL	IMPIANTO DI FILTRAZIONE FILTERING SYSTEM	CODICE CODE	BANCALE cm. PALLET	PESO Kg WEIGHT	N. BANCALI PALLET N°
<b>24</b> RATTAN	1 SKIMMER <b>10 M<sup>3</sup> H SAND FILTERING SYSTEM</b>	XC24...S10R	100 x 140 x 240 h	357	1
	1 SKIMMER <b>11 M<sup>3</sup> H CARTRIDGE FILTERING SYSTEM</b>	XC24...C11R	100 x 140 x 240 h	330	1
<b>25</b> RATTAN	1 SKIMMER <b>10 M<sup>3</sup> H SAND FILTERING SYSTEM</b>	XC25...S10R	100 x 140 x 240 h	386	1
	1 SKIMMER <b>11 M<sup>3</sup> H CARTRIDGE FILTERING SYSTEM</b>	XC25...C11R	100 x 140 x 240 h	360	1
<b>35</b> RATTAN	1 SKIMMER <b>10 M<sup>3</sup> H SAND FILTERING SYSTEM</b>	XC35...S10R	100 x 140 x 240 h	432	1
	1 SKIMMER <b>11 M<sup>3</sup> H CARTRIDGE FILTERING SYSTEM</b>	XC35...C11R	100 x 140 x 240 h	410	1
<b>36</b> RATTAN	1 SKIMMER <b>10 M<sup>3</sup> H SAND FILTERING SYSTEM</b>	XC36...S10R	100 x 140 x 240 h 100 x 120 x 110 h	565	2
	1 SKIMMER <b>11 M<sup>3</sup> H CARTRIDGE FILTERING SYSTEM</b>	XC36...C11R	100 x 140 x 240 h 100 x 120 x 90 h	520	2
<b>37</b> RATTAN	1 SKIMMER <b>10 M<sup>3</sup> H SAND FILTERING SYSTEM</b>	XC37...S10R	100 x 140 x 240 h 100 x 120 x 135 h	575	2
	1 SKIMMER <b>11 M<sup>3</sup> H CARTRIDGE FILTERING SYSTEM</b>	XC37...C11R	100 x 140 x 240 h 100 x 120 x 100 h	565	2
<b>48</b> RATTAN	1 SKIMMER <b>10 M<sup>3</sup> H SAND FILTERING SYSTEM</b>	KITDVC48...S10R	100 x 140 x 240 h 100 x 120 x 140 h	645	2
<b>49</b> RATTAN	2 SKIMMERS <b>15 M<sup>3</sup> H SAND FILTERING SYSTEM</b>	XC49...S15R	100 x 140 x 240 h 100 x 120 x 150 h 100 x 120 x 160 h	720	3
<b>510</b> RATTAN	2 SKIMMERS <b>15 M<sup>3</sup> H SAND FILTERING SYSTEM</b>	XC510...S15R	100 x 140 x 240 h 100 x 120 x 160 h 100 x 120 x 170 h	860	3

NOTA: I pesi e le misure per kit piscina con filtro a sabbia si riferiscono a filtri con valvola top.  
NOTE: All the weights and sizes for sand filter pools kit are related to top-valve models.

# DIVA

MODELLO MODEL	IMPIANTO DI FILTRAZIONE FILTERING SYSTEM	CODICE CODE	BANCALE cm. PALLET	PESO Kg WEIGHT	N. BANCALI PALLET N°
<b>24</b> DIVA	1 SKIMMER <b>10 M<sup>3</sup> H SAND FILTERING SYSTEM</b>	XC24...S10D	100 x 140 x 240 h 100 x 120 x 120 h	332	2
	1 SKIMMER <b>11 M<sup>3</sup> H CARTRIDGE FILTERING SYSTEM</b>	XC24...C11D	100 x 140 x 240 h 100 x 120 x 120 h	310	2
<b>25</b> DIVA	1 SKIMMER <b>10 M<sup>3</sup> H SAND FILTERING SYSTEM</b>	XC25...S10D	100 x 140 x 240 h 100 x 120 x 120 h	356	2
	1 SKIMMER <b>11 M<sup>3</sup> H CARTRIDGE FILTERING SYSTEM</b>	XC25...C11D	100 x 140 x 240 h 100 x 120 x 110 h	330	2
<b>35</b> DIVA	1 SKIMMER <b>10 M<sup>3</sup> H SAND FILTERING SYSTEM</b>	XC35...S10D	100 x 140 x 240 h 100 x 120 x 180 h	389	2
	1 SKIMMER <b>11 M<sup>3</sup> H CARTRIDGE FILTERING SYSTEM</b>	XC35...C11D	100 x 140 x 240 h 100 x 120 x 180 h	360	2
<b>36</b> DIVA	1 SKIMMER <b>10 M<sup>3</sup> H SAND FILTERING SYSTEM</b>	XC36...S10D	100 x 140 x 240 h 100 x 120 x 180 h	435	2
	1 SKIMMER <b>11 M<sup>3</sup> H CARTRIDGE FILTERING SYSTEM</b>	XC36...C11D	100 x 140 x 240 h 100 x 120 x 180 h	415	2
<b>37</b> DIVA	1 SKIMMER <b>10 M<sup>3</sup> H SAND FILTERING SYSTEM</b>	XC37...S10D	100 x 140 x 240 h 100 x 120 x 190 h	472	2
	1 SKIMMER <b>11 M<sup>3</sup> H CARTRIDGE FILTERING SYSTEM</b>	XC37...C11D	100 x 140 x 240 h 100 x 120 x 180 h	445	2
<b>48</b> DIVA	1 SKIMMER <b>10 M<sup>3</sup> H SAND FILTERING SYSTEM</b>	XC48...S10D	100 x 140 x 250 h 100 x 120 x 200 h	636	2
<b>49</b> DIVA	2 SKIMMERS <b>15 M<sup>3</sup> H SAND FILTERING SYSTEM</b>	XC49...S15D	100 x 140 x 240 h 100 x 120 x 130 h 100 x 120 x 150 h	680	3
<b>510</b> DIVA	2 SKIMMERS <b>15 M<sup>3</sup> H SAND FILTERING SYSTEM</b>	XC510...S15D	100 x 120 x 170 h 100 x 120 x 170 h 100 x 140 x 220 h	750	3

NOTA: I pesi e le misure per kit piscina con filtro a sabbia si riferiscono a filtri con valvola top.  
NOTE: All the weights and sizes for sand filter pools kit are related to top-valve models.

## DIVA LTI

MODELLO MODEL	IMPIANTO DI FILTRAZIONE FILTERING SYSTEM	CODICE CODE	BANCALE cm. PALLET	PESO Kg WEIGHT	N. BANCALI PALLET N°
<b>35</b> DIVA LTI	1 SKIMMER <b>10 M<sup>3</sup> H SAND FILTERING SYSTEM</b>	XC35...S10DG	100 x 140 x 240 h 100 x 120 x 200 h	410	2
	1 SKIMMER <b>11 M<sup>3</sup> H CARTRIDGE FILTERING SYSTEM</b>	XC35...C11DG	100 x 140 x 240 h 100 x 120 x 200 h	374	2
<b>36</b> DIVA LTI	1 SKIMMER <b>10 M<sup>3</sup> H SAND FILTERING SYSTEM</b>	XC36...S10DG	100 x 140 x 240 h 100 x 120 x 200 h	455	2
	1 SKIMMER <b>11 M<sup>3</sup> H CARTRIDGE FILTERING SYSTEM</b>	XC36...C11DG	100 x 140 x 240 h 100 x 120 x 200 h	425	2
<b>37</b> DIVA LTI	1 SKIMMER <b>10 M<sup>3</sup> H SAND FILTERING SYSTEM</b>	XC37...S10DG	100 x 140 x 240 h 100 x 120 x 210 h	492	2
	1 SKIMMER <b>11 M<sup>3</sup> H CARTRIDGE FILTERING SYSTEM</b>	XC37...C11DG	100 x 140 x 240 h 100 x 120 x 210 h	465	2
<b>48</b> DIVA LTI	1 SKIMMER <b>10 M<sup>3</sup> H SAND FILTERING SYSTEM</b>	XC48...S10DG	100 x 140 x 240 h 100 x 120 x 180 h 100 x 120 x 120 h	656	3
<b>49</b> DIVA LTI	2 SKIMMERS <b>15 M<sup>3</sup> H SAND FILTERING SYSTEM</b>	XC49...S15DG	100 x 140 x 240 h 100 x 120 x 160 h 100 x 120 x 140 h	700	3

## NAKED

<b>24</b> NAKED	1 SKIMMER <b>10 M<sup>3</sup> H SAND FILTERING SYSTEM</b>	XC24...S10N	100 x 140 x 240 h	357	1
	1 SKIMMER <b>11 M<sup>3</sup> H CARTRIDGE FILTERING SYSTEM</b>	XC24...C11N	100 x 140 x 240 h	330	1
<b>25</b> NAKED	1 SKIMMER <b>10 M<sup>3</sup> H SAND FILTERING SYSTEM</b>	XC25...S10N	100 x 140 x 240 h	386	1
	1 SKIMMER <b>11 M<sup>3</sup> H CARTRIDGE FILTERING SYSTEM</b>	XC25...C11N	100 x 140 x 240 h	360	1
<b>35</b> NAKED	1 SKIMMER <b>10 M<sup>3</sup> H SAND FILTERING SYSTEM</b>	XC35...S10N	100 x 140 x 240 h	432	1
	1 SKIMMER <b>11 M<sup>3</sup> H CARTRIDGE FILTERING SYSTEM</b>	XC35...C11N	100 x 140 x 240 h	410	1
<b>36</b> NAKED	1 SKIMMER <b>10 M<sup>3</sup> H SAND FILTERING SYSTEM</b>	XC36...S10N	100 x 140 x 240 h	565	1
	1 SKIMMER <b>11 M<sup>3</sup> H CARTRIDGE FILTERING SYSTEM</b>	XC36...C11N	100 x 140 x 240 h	520	1
<b>37</b> NAKED	1 SKIMMER <b>10 M<sup>3</sup> H SAND FILTERING SYSTEM</b>	XC37...S10N	100 x 140 x 240 h	575	1
	1 SKIMMER <b>11 M<sup>3</sup> H CARTRIDGE FILTERING SYSTEM</b>	XC37...C11N	100 x 140 x 240 h	565	1
<b>48</b> NAKED	1 SKIMMER <b>10 M<sup>3</sup> H SAND FILTERING SYSTEM</b>	XC48...S10N	100 x 140 x 240 h	645	1
<b>49</b> NAKED	2 SKIMMERS <b>15 M<sup>3</sup> H SAND FILTERING SYSTEM</b>	XC49...S15N	100 x 140 x 240 h 100 x 120 x 130 h	720	2
<b>510</b> NAKED	2 SKIMMERS <b>15 M<sup>3</sup> H SAND FILTERING SYSTEM</b>	XC510...S15N	100 x 140 x 240 h 100 x 120 x 130 h	860	2

NOTA: I pesi e le misure per kit piscina con filtro a sabbia si riferiscono a filtri con valvola top.  
NOTE: All the weights and sizes for sand filter pools kit are related to top-valve models..

## KIT BASAMENTO PER MONTAGGIO SENZA CEMENTO

### STEEL BASEMENT STRUCTURE FOR ASSEMBLY WITHOUT CONCRETE SLAB

MODELLO MODEL	DESCRIZIONE DESCRIPTION	CODICE CODE	BANCALE cm. PALLET	PESO Kg WEIGHT	N. BANCALI PALLET N°
<b>KIT x 24</b>	<b>KIT PREFABBRICATO IN ACCIAIO PER MONTAGGIO SENZA SOLETTA IN C.A.</b> STEEL BASEMENT STRUCTURE FOR ASSEMBLY WITHOUT CONCRETE SLAB	JDVC24KITTB	80 x 125 x 50 h	152	1
<b>KIT x 25</b>	<b>KIT PREFABBRICATO IN ACCIAIO PER MONTAGGIO SENZA SOLETTA IN C.A.</b> STEEL BASEMENT STRUCTURE FOR ASSEMBLY WITHOUT CONCRETE SLAB	JDVC25KITTB	80 x 125 x 75 h	181	1
<b>KIT x 35</b>	<b>KIT PREFABBRICATO IN ACCIAIO PER MONTAGGIO SENZA SOLETTA IN C.A.</b> STEEL BASEMENT STRUCTURE FOR ASSEMBLY WITHOUT CONCRETE SLAB	JDVC35KITTB	80 x 180 x 50 h	215	1
<b>KIT x 36</b>	<b>KIT PREFABBRICATO IN ACCIAIO PER MONTAGGIO SENZA SOLETTA IN C.A.</b> STEEL BASEMENT STRUCTURE FOR ASSEMBLY WITHOUT CONCRETE SLAB	JDVC36KITTB	80 x 180 x 60 h	252	1
<b>KIT x 37</b>	<b>KIT PREFABBRICATO IN ACCIAIO PER MONTAGGIO SENZA SOLETTA IN C.A.</b> STEEL BASEMENT STRUCTURE FOR ASSEMBLY WITHOUT CONCRETE SLAB	JDVC37KITTB	80 x 180 x 70 h	289	1
<b>KIT x 48</b>	<b>KIT PREFABBRICATO IN ACCIAIO PER MONTAGGIO SENZA SOLETTA IN C.A.</b> STEEL BASEMENT STRUCTURE FOR ASSEMBLY WITHOUT CONCRETE SLAB	JDVC48KITTB	80 x 180 x 100 h	350	1
<b>KIT x 49</b>	<b>KIT PREFABBRICATO IN ACCIAIO PER MONTAGGIO SENZA SOLETTA IN C.A.</b> STEEL BASEMENT STRUCTURE FOR ASSEMBLY WITHOUT CONCRETE SLAB	JDVC49KITTB	80 x 180 x 120 h	387	1
<b>KIT x 510</b>	<b>KIT PREFABBRICATO IN ACCIAIO PER MONTAGGIO SENZA SOLETTA IN C.A.</b> STEEL BASEMENT STRUCTURE FOR ASSEMBLY WITHOUT CONCRETE SLAB	JDVC510KITTB	80 x 180 x 155 h	578	1

## KIT NUOTO CONTRO CORRENTE - SWIM SYSTEM

MODELLO MODEL	DESCRIZIONE DESCRIPTION	CODICE CODE	BANCALE cm. PALLET	PESO Kg WEIGHT	N. BANCALI PALLET N°
<b>KIT x 3 m.</b>	<b>KIT NUOTO CONTRO CORRENTE</b> SWIMMING AGAINST THE CURRENT KIT	JDVKITNCC030	100 x 120 x 100 h	50	1
<b>KIT x 4 m.</b>	<b>KIT NUOTO CONTRO CORRENTE</b> SWIMMING AGAINST THE CURRENT KIT	JDVKITNCC040	100 x 120 x 110 h	60	1

## KIT IDROMASSAGGIO A 7 GETTI - 7 JETS HYDROMASSAGE KIT

MODELLO MODEL	DESCRIZIONE DESCRIPTION	CODICE CODE	BANCALE cm. PALLET	PESO Kg WEIGHT	N. BANCALI PALLET N°
<b>KIT x 3 m.</b>	<b>KIT IDROMASSAGGIO A 7 GETTI</b> 7 JETS HYDROMASSAGE KIT	JDVKITIDR0030	80 x 120 x 50 h	30	1
<b>KIT x 4 m.</b>	<b>KIT IDROMASSAGGIO A 7 GETTI</b> 7 JETS HYDROMASSAGE KIT	JDVKITIDR0040	80 x 120 x 60 h	35	1

## DIMENSIONI PLATEA DOLCEVITA (esclusa DIVA LTI) BASEMENT SIZES (NOT FOR DOLCEVITA DIVA LTI)

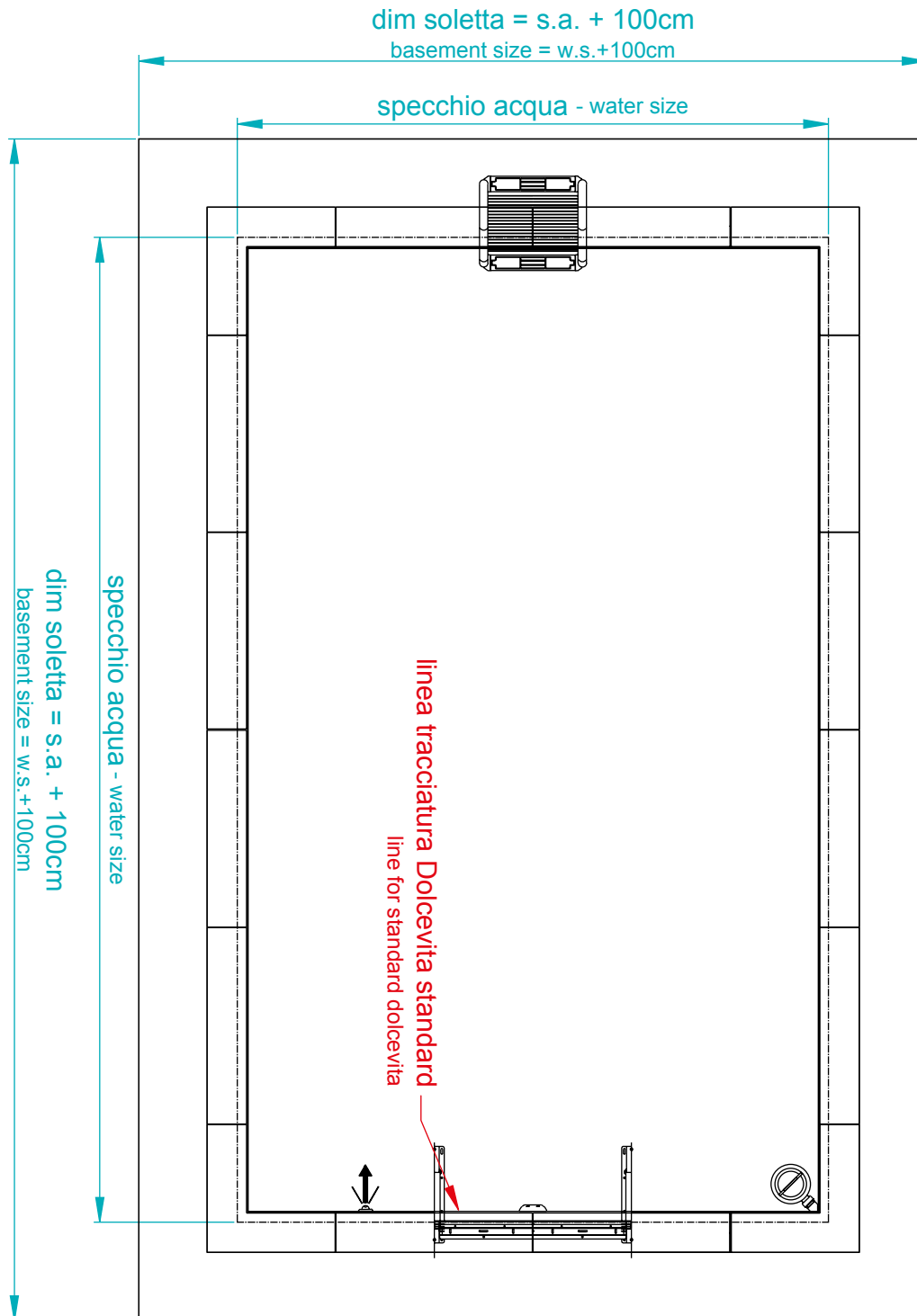

# DIMENSIONI PLATEA PER DOLCEVITA DIVA LTI

## BASEMENT SIZES FOR DOLCEVITA DIVA LTI

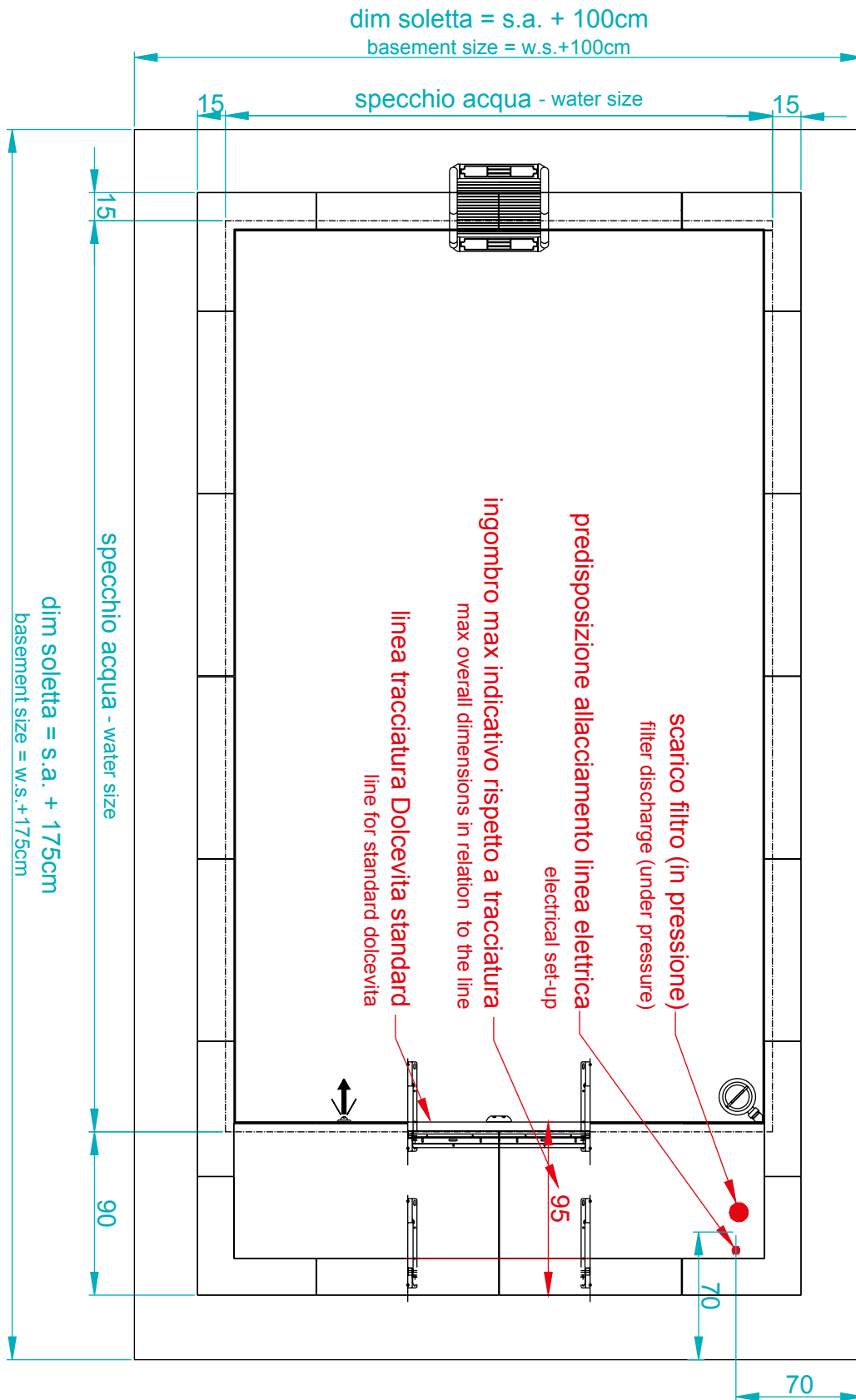

## CARATTERISTICHE OPERE CIVILI

### CONCRETE BASE

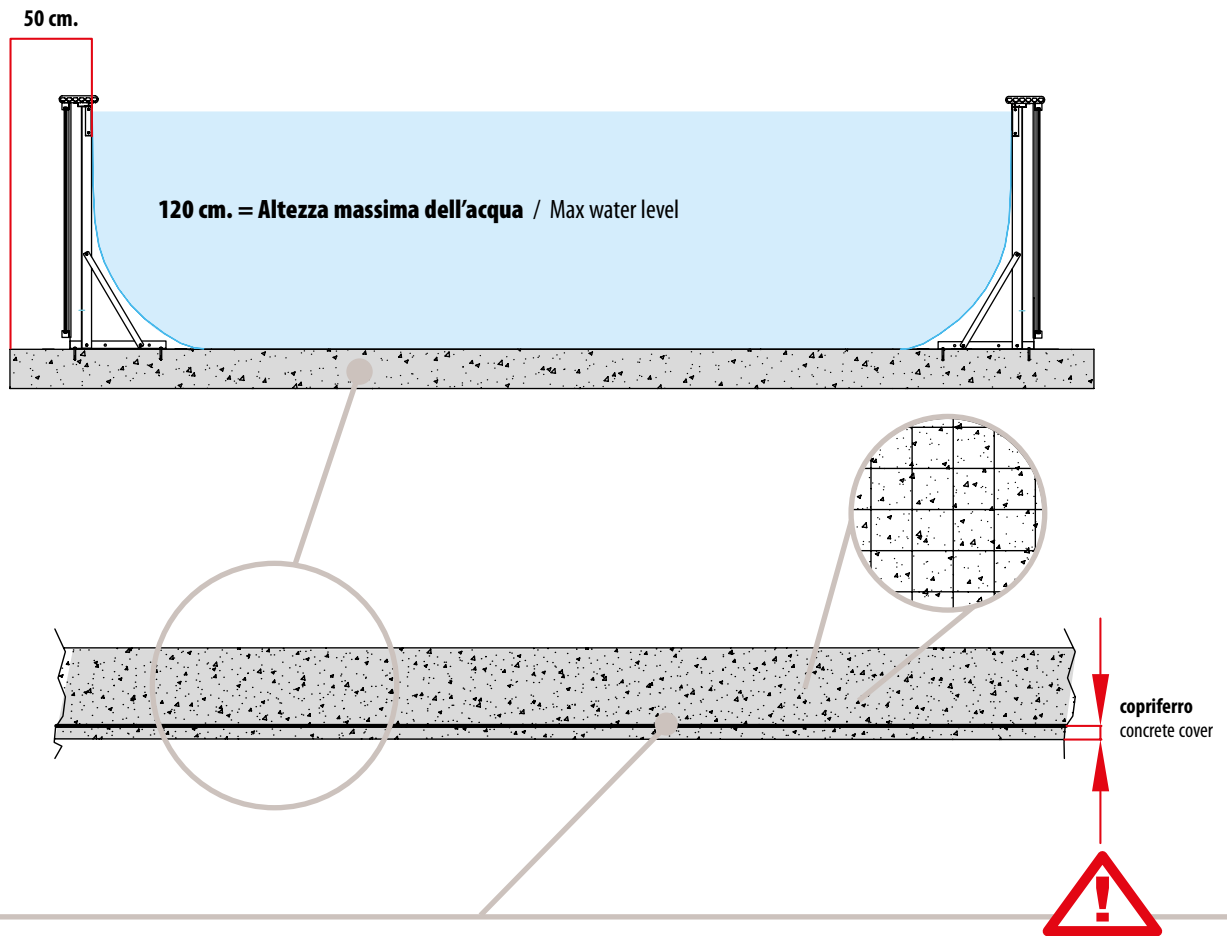

**Verificare con il vostro ingegnere le specifiche ottimali alla vostra installazione**

*Check with your engineer which are the optimal requirements for your installation*

**Verificare che la soletta sia effettivamente rettangolare con le diagonali uguali**

*Check the basement is really rectangular with the same diagonals*

**Verificare in caso di terreno instabile o franoso con perizia geologica la realizzabilità della soletta**

*Check the basement is achievable in case of unstable ground by geological expertise*

**La superficie del getto deve essere finita e lisciata senza imperfezioni**

*The basement surface must be smooth without imperfections*

**Tolleranza dislivello del piano perimetrale del getto =  $\pm 1$  cm.**

*Tolerance gradient of the perimeter of slab =  $\pm 1$  cm.*



## POSIZIONE STANDARD ACCESSORI SKIMMER, MANDATA E FARO A LED

STANDARD ACCESSORIES POSITION - SKIMMER, INLET AND LIGHT

24

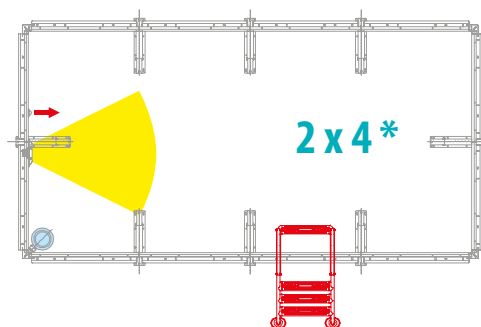

25

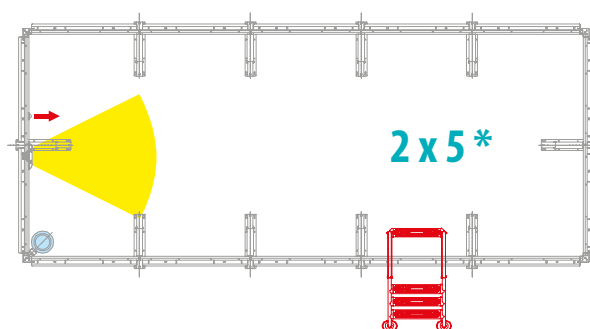

35

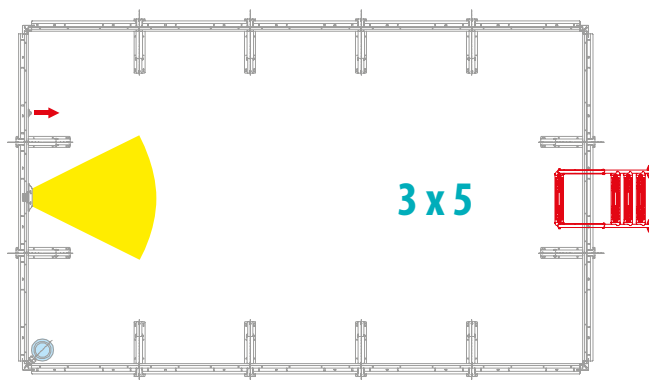

36

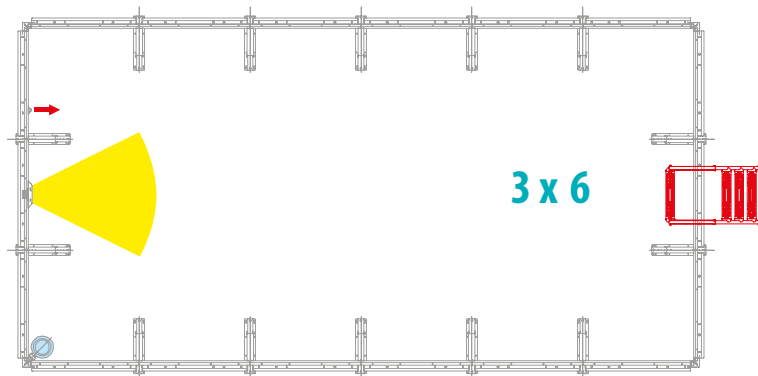

\* PER QUESTE DIMENSIONI NON E' POSSIBILE POSIZIONARE LA SCALA AL CENTRO DEL LATO CORTO  
\* this sizes don't allow to place the ladder in the center of the short side

37

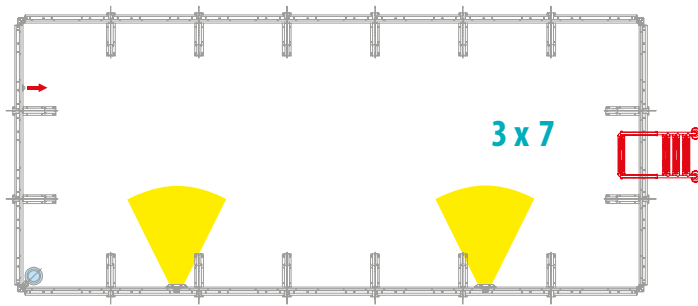

48

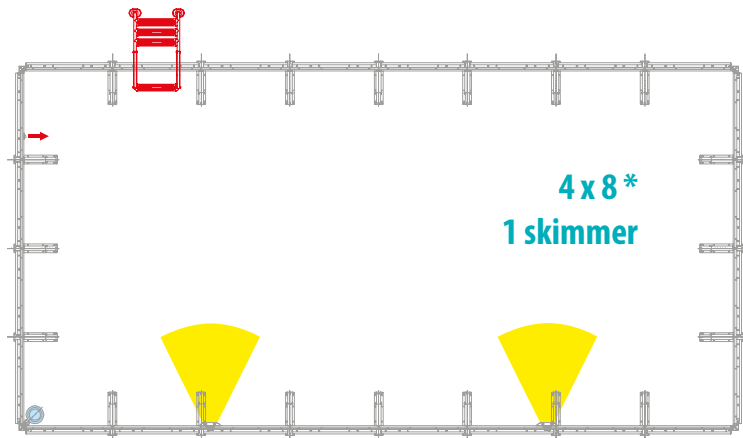

49

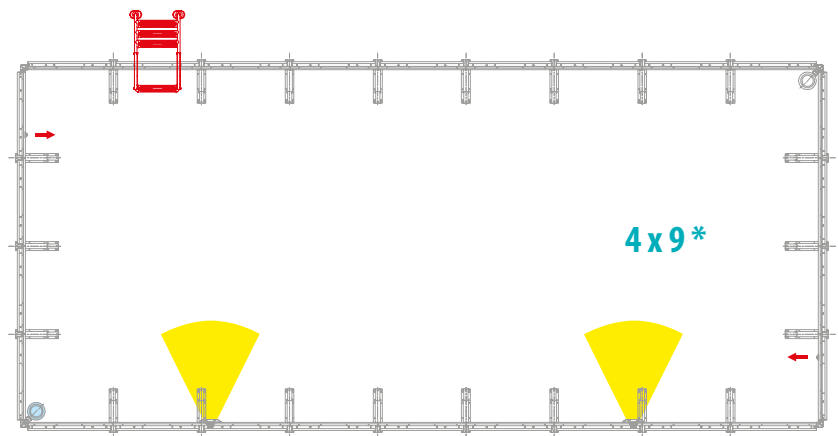

510

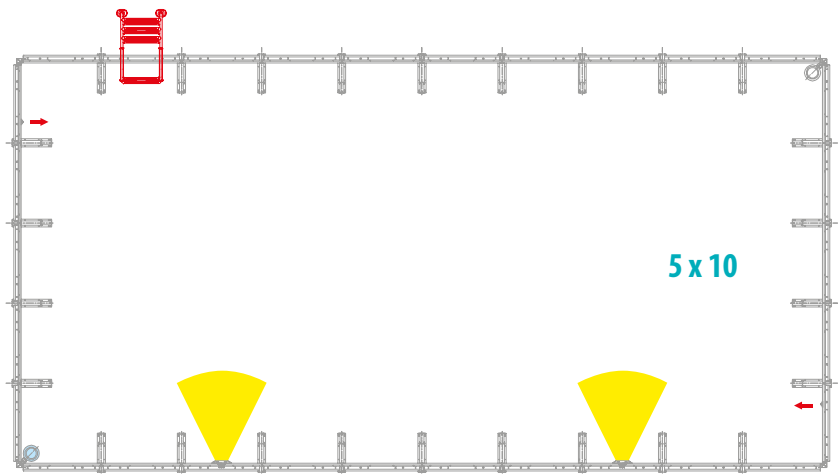

\* PER QUESTE DIMENSIONI NON E' POSSIBILE POSIZIONARE LA SCALA AL CENTRO DEL LATO CORTO  
\* this sizes don't allow to place the ladder in the center of the short side



# CONDIZIONI DI GARANZIA

Ogni piscina Laghetto è prodotta con materiali selezionati e secondo determinate procedure di qualità.

Ogni piscina Laghetto è coperta da garanzia per la durata di 24 mesi.

Per quanto riguarda le garanzie aggiuntive, previa registrazione effettuata entro 30 (trenta) giorni dalla data di consegna, tramite il modulo dedicato sul sito [www.piscinelaghetto.com](http://www.piscinelaghetto.com), l'utente finale, fornendo la documentazione necessaria (fattura o documento di vendita e, ove richiesto, numero di matricola del Prodotto) potrà richiedere le seguenti garanzie aggiuntive:

Il "telo" e la "struttura metallica" della piscina modello "Classic" potranno essere coperti da una garanzia per la durata di anni 3 (tre).

Il "telo" e la "struttura metallica" delle piscine modello "Pop!", "Dolcevita", "Playa", "Divina", "Divina Infinity", "Ninfea" potranno essere coperti da una garanzia per la durata di anni 5 (cinque) sostituite o riparate ai sensi della presente garanzia non prolungano il periodo di garanzia del Prodotto originale, ma godono di una garanzia propria.

In ogni caso la garanzia è operante solo in caso di uso conforme e corretto delle piscine, dei prodotti e dei componenti ed a condizione che gli stessi siano installati da personale qualificato, specializzato e certificato da Fluidra.

La garanzia non copre utilizzi del prodotto non espressamente previsti dal produttore.

La garanzia è franco fabbrica e copre, per il periodo di 24 mesi o per il maggior periodo di garanzia come sopra accordato, i costi del materiale e della manodopera necessari all'intervento di riparazione e/o ripristino del prodotto, che saranno effettuati presso la sede di Vescovato (CR), in Ex S.S. Padana Inferiore, 11/C.

Ad insindacabile giudizio di Fluidra, qualora la riparazione o il ripristino non risultassero possibili o fossero antieconomici, si procederà alla sostituzione del prodotto con altro avente identiche o analoghe caratteristiche.

Tutti i costi sostenuti da Fluidra, relativamente agli interventi di riparazione e/o ripristino del bene, effettuati al di fuori del termine di garanzia, sono sempre a carico del cliente.

Decorso il periodo di garanzia, il costo delle riparazioni e di ogni onere connesso (ad es. spese di spedizione) è interamente a carico dell'acquirente.

Decorso il periodo di garanzia, non sarà assicurata la disponibilità di materiali e ricambi in sostituzione di quelli risultati eventualmente difettosi.

Nessuna responsabilità in tal senso può essere addebitata al produttore e/o al venditore.

La garanzia come sopra accordata decorre dalla data di consegna del prodotto al Cliente finale ed è valida per il periodo indicato in questo listino (24 mesi) o 3 anni o 5 anni, a condizione che il cliente finale sia in possesso del documento fiscale che ne comprovi l'acquisto e la richiesta di estensione di garanzia venga effettuata entro 30 (trenta) giorni dalla data di acquisto del Prodotto.

Eventuali danni derivati ai prodotti per gelo o per uso inappropriato di prodotti chimici o utilizzo di prodotti chimici di marchi non appartenenti a Fluidra, ovvero di altri produttori, non comunicati e specificatamente approvati da Fluidra, sono esclusi dalla garanzia.

Sono altresì esclusi dalle condizioni di garanzia i vizi e malfunzionamenti imputabili ad uso scorretto del bene.

Gli oneri dovuti allo svuotamento, riempimento e trattamento chimico dell'acqua non sono mai coperti da garanzia e pertanto non possono essere imputabili a Fluidra. Altre condizioni di esclusione sono espressamente indicate nello specifico certificato di garanzia che accompagna il prodotto e nelle condizioni generali di vendita di Fluidra.

Affinché la presente garanzia sia efficace, l'acquirente deve fornire la prova della data di acquisto e di ricezione del Prodotto. Inoltre, l'Acquirente dovrà seguire scrupolosamente le istruzioni del Venditore contenute nella documentazione di cui è corredato il Prodotto, ove applicabile, in funzione della gamma e del modello del Prodotto.

Le parti sostituite o riparate ai sensi della presente garanzia non prolungano il periodo di garanzia del Prodotto originale, ma godono di una garanzia propria.

PISCINE  
LAGHETTO®

## IMPORTANTE:

1 - Il telo vasca è costituito da una membrana in tessuto poliestere (trevira) spalmato p.v.c. assemblato in un unico pezzo. Al primo riempimento e nelle prime settimane di utilizzo, possono evidenziarsi trasudazioni del telo vasca sotto forma di gocciolamenti, in particolare negli angoli. È una condizione fisiologica del materiale che non pregiudica in alcun caso la tenuta meccanica e la durata del telo e non ne rappresenta un difetto. Pertanto non dà diritto a richieste di sostituzioni in garanzia del materiale stesso. Si raccomanda di lasciare asciugare la trasudazione senza rimuoverne le gocce, il fenomeno è destinato a sparire in breve tempo. La durata del fenomeno può variare a seconda del luogo di installazione, della temperatura esterna e/o della piscina e dall'uso di prodotti di trattamento adeguati.

2 - In particolari condizioni ambientali possono nascere sul telo vasca muffe resistenti. Queste non incidono né sulla durata, né sulla robustezza del materiale, non ne pregiudicano in alcun modo l'utilizzo, non rappresentano difetto, non danno pertanto diritto ad alcuna richiesta di sostituzione in garanzia.

3 - Il telo vasca può subire variazioni nel proprio colore originale nel tempo a causa del suo invecchiamento, dell'esposizione prolungata ai raggi solari e/o intemperie e dall'uso continuo di prodotti chimici di trattamento e/o pulizia. Questo fenomeno non incide sulla tenuta strutturale del prodotto, non pregiudica in alcun modo il suo utilizzo, non dà pertanto diritto ad alcuna richiesta di sostituzione in garanzia.

4 - L'ossidazione di parti metalliche dovute a mancata o insufficiente manutenzione ovvero manutenzione non effettuata in conformità alle istruzioni dei Prodotti Piscine Laghetto e/o alla diligenza richiesta dalla natura del prodotto non sono da considerarsi difetto, non incidono sulla tenuta strutturale del prodotto, non pregiudicano in alcun modo il suo utilizzo, non danno pertanto diritto ad alcuna richiesta di sostituzione in garanzia.

5 - Tutte le parti di finitura dei prodotti (a titolo esemplificativo: pannellature, bordi, tessuti) sono realizzate prevalentemente a mano. In tal senso alcune imperfezioni in queste parti sono da considerarsi come caratteristica intrinseca e accettata del prodotto. Le stesse non influiscono sull'uso a cui il prodotto stesso è destinato. Non sono da considerarsi difetto, non incidono sulla tenuta strutturale del prodotto, non pregiudicano in alcun modo il suo utilizzo, non danno pertanto diritto ad alcuna richiesta di sostituzione in garanzia.

6 - La garanzia estesa di 3 o 5 anni su telo e struttura metallica non si applica qualora sul prodotto Dolcevita, Divina, Pop o Classic venga installato un sistema di elettrolisi a sale. In questo caso il periodo di garanzia è limitato a 2 anni. Sul prodotto Playa l'installazione di un sistema di elettrolisi a sale e/o di altro tipo di impianto di filtrazione/disinfezione diverso da quello originale fornito da Fluidra contestualmente all'acquisto del prodotto, fa automaticamente decadere la garanzia fornita dal produttore.

7 - La garanzia non si applica al bordo vasca di qualunque tipologia delle piscine Dolcevita, Divina, Pop!, Classic qualora ne venga fatto un uso scorretto, ovvero non conforme alle istruzioni di montaggio, uso e/o manutenzione fornite con la piscina stessa.

Ogni ulteriore dettaglio riguardante la garanzia (oggetto, durata, esclusioni, inapplicabilità, decadenza, oneri, responsabilità per danni) sono incluse nelle CONDIZIONI GENERALI DI VENDITA e, in maggiore dettaglio, nei certificati

Piscine Laghetto, nelle istruzioni di installazione e manutenzione che accompagnano i prodotti.

CI RISERVIAMO IL DIRITTO DI MODIFICARE, ANCHE SENZA PREAVVISO, TOTALMENTE O PARZIALMENTE IL CONTENUTO DI QUESTO DOCUMENTO.



ATTENZIONE

## GARANZIA ESTESA | Extended warranty

Per ottenere l'estensione di garanzia pubblicizzata su questo catalogo il prodotto deve essere registrato dal cliente finale sul sito [www.piscinelaghetto.com](http://www.piscinelaghetto.com) entro 30 giorni dalla data di consegna della piscina, comprovata da regolare ricevuta fiscale/fattura.

In order to obtain the extended warranty advertised in this catalogue, the product must be registered by the end customer on [www.piscinelaghetto.com](http://www.piscinelaghetto.com) within 30 days from the date of sale/delivery of the pool, proven by regular fiscal receipt/invoice.

*Dolce Vita*



# WARRANTY CONDITIONS

Each Laghetto pool is manufactured from selected materials and according to certain quality procedures.

Each Laghetto pool is covered by a 24-month guarantee.

As regards additional warranties, upon written request within 30 (thirty) days from the date of purchase/delivery and through the dedicated form on the website [www.piscinelaghetto.com](http://www.piscinelaghetto.com), the end user, providing the necessary documentation (invoice or purchase document and, where required, serial number of the Product) may request the following additional guarantees:

The "liner" and the "metal structure" of the "Classic" swimming pool model may be covered by a guarantee for the duration of 3 (three) years.

The "liner" and the "metal structure" of the "Pop!", "Dolcevita", "Playa", "Divina", "Divina Infinity", "Ninfea" swimming pools models, shall be covered by a guarantee for the duration of 5 (five) years.

In any case, the guarantee shall apply only in the event of proper and correct use of the pools, products and components and on the condition that they are installed by qualified, specialised and Fluidra-certified service personnel.

The warranty does not cover uses of the product not expressly intended by the manufacturer.

The warranty is 'ex-works' and covers, for the period of 24 months or for the longer warranty period as agreed upon above, the costs of the material and labour necessary for the repair and/or restoration of the product, which will be carried out at the premises in Vescovato (CR), ex.s.s. Padana Inferiore, 11/C, Italy. At Fluidra's unquestionable discretion, should repair or restoration not be possible or not be economic, the product shall be replaced with another product having identical or similar characteristics.

All costs incurred by Fluidra with respect to repair and/or restoration of the product, carried out outside of the warranty period, shall always be charged to the customer.

Once the warranty period has expired, the cost of repairs and any related charges (e.g. shipping costs) shall be borne entirely by the customer.

After the expiry of the guarantee period, the availability of materials and spare parts to replace those that may prove to be defective shall not be ensured. No liability in this respect can be charged to the manufacturer and/or to the retailer.

The warranty as granted above shall run from the date of delivery/sale of the product to the end Customer and shall be valid for the period indicated in this price list (24 months) or 3 years or 5 years, on condition that the end Customer is in possession of the fiscal document proving the purchase and the request for extension of the warranty is made within 30 (thirty) days from the date of purchase of the Product.

Any damage caused to the products by frost or inappropriate use of chemicals or use of chemicals of brands not belonging to Fluidra, or of other manufacturers, not disclosed and specifically approved by Fluidra, are excluded from the warranty. Also excluded from the warranty conditions are defects and malfunctions due to improper and/or incorrect use of the goods.

Charges due to emptying, filling and chemical treatment of water are never covered by warranty and therefore cannot be blamed to Fluidra. Other exclusion conditions are expressly stated in the specific warranty certificate accompanying the product and in Fluidra's general terms and conditions of sale.

For this warranty to be effective, the purchaser must provide proof of the date of purchase and receipt of the Product. Furthermore, the Buyer shall scrupulously follow the Seller's instructions contained in the documentation accompanying the Product, where applicable, depending on the range and model of the Product.

Parts replaced or repaired under warranty shall not extend the warranty period of the original Product, but shall have their own warranty period.

## IMPORTANT:

1 - The pool liner consists of a membrane made of polyester fabric (trevira) coated with PVC, assembled in one piece. Temporary phenomena of exudation of the pool liner (dripping), due to the type of material used and the welding process of the pvc liner itself, may be evident in particular at the first filling and in the first weeks of use of the product. This is a physiological condition of the material which in no way affects the mechanical tightness life of the pool liner and does not represent a defect. It therefore does not give any right to warranty claims for the material itself. In the event of dripping, it is recommended to allow the dripping to dry without removing the drops in order to accelerate the closing of the weave of the liner. The duration of the phenomenon may vary depending on the place of installation, the temperature outside and/or in the pool and the use of suitable treatment products.

2 - Under certain environmental conditions, resistant mould may develop on the pool liner. These do not affect either the durability or the strength of the material, do not affect its use in any way, do not represent a defect and do not give rise to any warranty claims.

3 - The pool liner may change in its original colour over time due to ageing, prolonged exposure to sunlight and/or weather conditions and the continuous use of treatment and/or cleaning chemicals. This phenomenon does not affect the structural strength of the product, does not affect its use in any way, and therefore does not give right to any warranty claim.

4 - Oxidation of metal parts due to lack of or inadequate maintenance or maintenance not carried out in accordance with Piscine Laghetto Product instruction manuals and/or the diligence required by the nature of the product are not to be considered a defect, do not affect the structural resistance of the product, do not prejudice its use in any way, and therefore do not give right to any request for replacement under warranty.

5 - All finishing parts of the products (by way of example: panelling, edges, fabrics) are mainly handmade. As a result, certain imperfections in these parts are to be considered as intrinsic and accepted characteristics of the product. They do not affect the use for which the product is intended. They are not to be considered a defect, do not affect the structural strength of the product, do not affect its use in any way, and therefore do not give rise to any warranty claim.

6 - The extended warranty of 3 or 5 years on the pool liner and metal structure does not apply if a salt electrolysis system is installed on the Dolcevita, Divina, Pop or Classic product. In this case the warranty period is limited to 2 years. On the Playa product the installation of a salt electrolysis system and/or any other type of filtration/disinfection system other than the original one supplied by Fluidra at the time of purchase of the product, automatically invalidates the warranty provided by the manufacturer.

7 - The warranty does not apply to the pool edge of any type of Dolcevita, Divina, Pop!, Classic pools if it is used incorrectly, i.e. not in accordance with the assembly, use and/or maintenance instructions supplied with the pool itself.

Any other further details concerning the warranty (object, duration, exclusions, inapplicability, charges, liability for damages) are included in the GENERAL CONDITIONS OF SALE and, in greater detail, in the PiscineLaghetto certificates included in the installation and maintenance manuals accompanying the products.

WE RESERVE THE RIGHT TO MODIFY, EVEN WITHOUT PRIOR NOTICE, ALL AND/OR PART OF THE CONTENTS OF THIS DOCUMENT.



## WARNING

### EXTENDED WARRANTY

In order to obtain the extended warranty advertised in this catalogue, the product must be registered by the end customer on [www.piscinelaghetto.com](http://www.piscinelaghetto.com) within 30 days from the date of sale/delivery of the pool, proven by regular fiscal receipt/invoice

*Dolce Vita*



PISCINE  
**LAGHETTO**<sup>®</sup>

[www.piscinelaghetto.com](http://www.piscinelaghetto.com)

**RESTA CONNESSO CON NOI**  
STAY CONNECTED



**50**

**1974**  
**2024**

*Dalce Vita*